

8275 Model 416 High Performance Ethernet
Workgroup Switch



User's Guide

8275 Model 416 High Performance Ethernet
Workgroup Switch



User's Guide

Note

Before using this information and the product it supports, be sure to read "Appendix A. Safety Information" on page 67 and "Appendix B. Notices" on page 73.

First Edition (May 1999)

This edition applies to Release 1.0 of the IBM 8275 Model 416 High Performance Ethernet Workgroup Switch.

Order publications through your IBM representative or the IBM branch office serving your locality. Publications are not stocked at the address given below.

A form for readers' comments appears at the back of this publication. If the form has been removed, address your comments to:

Department CGF
Design & Information Development
IBM Corporation
PO Box 12195
RESEARCH TRIANGLE PARK NC 27709
USA

When you send information to IBM, you grant IBM a nonexclusive right to use or distribute the information in any way it believes appropriate without incurring any obligation to you.

© **Copyright International Business Machines Corporation 1999. All rights reserved.**

US Government Users Restricted Rights – Use duplication or disclosure restricted by GSA ADP Schedule Contract with IBM Corp.

Contents

Figures	vii
Tables	ix
About This Guide	xi
Who Should Use This Guide	xi
How This Manual is Organized.	xi
Accessing the Softcopy Library	xi
Online Support	xii
Obtaining Service	xii
Chapter 1. Introduction	1
Product Overview	1
8275-416 Functions.	1
Layer 2 Switching	1
Management and User Interfaces.	2
Security	3
Reliability and Serviceability.	3
Performance	3
Year 2000 (Y2K)	3
Hardware	4
Cabling Requirements	4
Front Panel.	5
8275-416 Status LEDs.	6
Ethernet Port LEDs	7
Feature Module LEDs	8
Physical Characteristics	9
Chapter 2. Accessing the 8275-416	11
Connectivity Methods	11
Out-of-Band Connectivity.	11
In-Band Connectivity - Telnet, Web, SNMP	13
Chapter 3. Configuring your 8275-416	17
Configuring IP information	17
Concepts About Making Configuration Changes	19
Making Configuration Changes	19
Processing Configuration Changes	19
Saving Configuration Changes Across a Reset or Power Cycle.	20
Making Configuration Changes via the Terminal Interface	20
Making Configuration Changes	20
Applying (Processing) Configuration Changes	21
Saving Configuration Changes Across a Reset or Power Cycle.	21
Making Configuration Changes via the Web Interface	22
Making Configuration Changes	22
Processing Configuration Changes	22
Saving Configuration Changes Across a Reset or Power Cycle.	23
Making Configuration Changes via SNMP	23
Making Configuration Changes	23
Processing Configuration Changes	23
Saving Configuration Changes Across a Reset or Power Cycle.	23
Chapter 4. Using the Terminal Interface	25

Login Panel.	25
The Main Menu	26
System Information	26
Inventory Information	27
System Description	28
Management	29
Configuring the 8275-416 for Network Connectivity	29
Configuring Serial Port.	30
Configuring for DHCP or BootP Server.	31
Configuring SNMP	33
Configuring Traps	36
Configuring Telnet	38
Ping	39
ARP Cache.	40
Device Configuration	42
Configuring the 8275-416.	42
Configuring Spanning Tree Protocol (STP)	46
Configuring Broadcast Storm Recovery	48
Configuring 802.3x Flow Control	49
Statistics	50
Port Summary Statistics	50
Port Detailed Statistics.	50
Management Statistics.	51
User Account Management	52
System Utilities	53
Saving Applied Changes	53
Logging Out	53
Handling Files	54
Reset Utility.	56
Resetting System	57
Resetting Configuration Data to Factory Default Values.	57
Resetting Passwords to Factory Default Values	58
Debug Utility	59
Chapter 5. Using the Web Interface	61
Web Page Layout	61
Starting the Web Interface	61
Commands	62
Chapter 6. Troubleshooting and Obtaining Service	63
Diagnosing Problems	63
Obtaining Software	63
Troubleshooting in a Network	63
Start of Troubleshooting Process	63
Choosing a Troubleshooting Procedure	64
Procedure A	64
Procedure B	64
Procedure C	65
Procedure D	65
Obtaining Service	65
Appendix A. Safety Information.	67
Appendix B. Notices	73
Notice to Users of Online Versions of This Book	73
Electronic Emission Notices.	73

Federal Communications Commission (FCC) Statement	73
Industry Canada Class A Emission Compliance Statement	74
Avis de conformité aux normes d'Industrie Canada	74
European Norm (EN) Statement	74
Japanese Voluntary Control Council for Interference (VCCI) Statement	75
Korean Communications Statement	75
Taiwanese Class A Warning Statement.	76
Class 1 Laser Statement	76
Class 1 LED Statement	76
Trademarks.	76
Appendix C. Cable Pinout Diagrams	79
Straight-Through 10BASE-T/100BASE-TX Cables.	79
Straight-Through 10BASE-T/100BASE-TX Cables for STP	80
Crossover 10BASE-T/100BASE-TX Cables	80
Crossover 10BASE-T/100BASE-TX Cables for STP	81
EIA-232 Port	81
Null-Modem Cables.	82
Appendix D. Interface Conventions for the Console.	83
Index	87
Readers' Comments — We'd Like to Hear from You.	93

Figures

1. Front Panel of the 8275-416	5
2. Status LEDs for the 8275-416	6
3. Port Status LEDs for the 8275-416 and the 10/100BASE-TX Ethernet Feature Module.	7
4. Status LEDs for the 10/100BASE-TX Ethernet Feature Module.. . . .	8
5. Status LEDs for the 100BASE-FX Ethernet Feature Module.	9
6. Out-of-Band Connectivity — Locally Attached Terminal	12
7. Out-of-Band Connectivity — Remotely Attached Terminal	12
8. In-Band Connectivity	14
9. Configuring BootP/Static DHCP.	18
10. Configuring Network Connectivity (IP Information).	18
11. Log In Panel for Terminal Interface	25
12. Main Menu for Terminal Interface	26
13. System Information Menu.	27
14. Inventory Information	27
15. System Description	28
16. Management Menu	29
17. Network Connectivity Configuration	29
18. Serial Port Configuration	31
19. Server Configuration.	33
20. SNMP Community Configuration	34
21. SNMP Trap Receiver Configuration	35
22. Trap Flags Configuration	36
23. Trap Log	37
24. Trap Log Status	38
25. Telnet Configuration	39
26. Ping.	40
27. ARP Cache	41
28. Device Configuration	42
29. Switch Configuration.	43
30. Port Configuration	44
31. Port Monitoring	46
32. Spanning Tree Switch Configuration/Status	47
33. Spanning Tree Port Configuration/Status	48
34. Broadcast Storm Recovery	49
35. 802.3x Flow Control	49
36. Port Summary Statistics	50
37. Port Detailed Statistics	51
38. Management Statistics	51
39. User Account Management Menu	52
40. Save Applied Changes Menu	53
41. Logout Utility	54
42. Downloading File to the 8275-416	55
43. Uploading File from the 8275-416	55
44. Reset Menu	57
45. Reset Menu	57
46. Reset Configuration Data to Factory Defaults	58
47. Reset Passwords to Factory Defaults	59
48. Straight-Through UTP Cable (RJ-45 to RJ-45), T568A	79
49. Straight-Through UTP Cable (RJ-45 to RJ-45), T568B	79
50. Straight-Through STP Cable (RJ-45 to IBM Data Connector)	80
51. Crossover UTP Cable (RJ-45 to RJ-45), T568A.	80
52. Crossover UTP Cable (RJ-45 to RJ-45), T568B.	80

53. Crossover STP Cable (RJ-45 to IBM Data ConnectorCrossover)	81
54. Pinout of the EIA-232 Port	81
55. EIA-232 Modem Cable for Terminal with 25-Pin Connector	82
56. EIA-232 Modem Cable for Terminal with 9-Pin Connector	82

Tables

1.	Ethernet Cable Requirements	4
2.	Connectivity Methods and Available User Interfaces	11
3.	MIBs Supported by the 8275-416	14
4.	Troubleshooting— Isolating Problems	64
5.	Special Keys and Commands Used with the Terminal Interface	83

About This Guide

This manual briefly describes the features and capabilities of the 8275 Model 416 High Performance Ethernet Workgroup Switch. However, its primary purpose is to describe how to use the capabilities offered by the 8275-416 to configure, obtain status information, and monitor performance of the switch in your network.

Who Should Use This Guide

This manual is intended for the network administrator or person responsible for integrating, maintaining and monitoring the 8275-416 in your network. The person responsible for coordinating installation and service for the 8275-416 will also find this manual useful.

How This Manual is Organized

This manual contains the following chapters and appendixes:

- Chapter 1. Introduction describes the functions and capabilities of the 8275-416 .
- Chapter 2. Accessing the 8275-416 describes the various physical methods of accessing the 8275-416 .
- Chapter 3. Configuring your 8275-416 describes initial configuration of IP information.
- Chapter 4. Using the Terminal Interface describes the using functions of the terminal interface.
- Chapter 5. Using the Web Interface introduces the Web interface.
- Chapter 6. Troubleshooting and Obtaining Service gives suggestions for solving problems obtaining service.
- Appendix A. Safety Information contains translated safety instructions to observe when performing troubleshooting procedures.
- Appendix B. Notices lists important notices about the use of this product.
- Appendix C. Cable Pinout Diagrams describes and illustrates pinout diagrams for ethernet and null modem cable connectors.
- Appendix D. Interface Conventions for the Console describes the definitions and functions of special keys and commands that are used by the terminal interface.

Accessing the Softcopy Library

Softcopy versions of 8275-416 product documentation is available from either the Documentation CD-ROM (shipped with the product) or the IBM Networking Products Web site. To access product documentation shipped on the CD-ROM, follow the instructions in the booklet that accompanies the CD-ROM. Visit the following Web site to access the 8275-416 documentation at:

<http://www.networking.ibm.com/did/8275bks.html>

Online Support

To obtain support information, including technical tips, current product information, and code updates and fixes for the 8275-416 , visit the IBM Networking Tech Support page at:

<http://www.networking.ibm.com/support>

You may also subscribe to receive e-mail notifications about code updates, tips, and FAQs for your 8275-416 .

Obtaining Service

If you need assistance in troubleshooting or you need service for your 8275–416, call IBM at:

- 1 800 772-2227 in the United States
- 1 800 426-7378 (1 800 IBM-SERV) in Canada.
- In other locations, contact your place of purchase.

Refer to your IBM Warranty for information concerning service for the product.

Chapter 1. Introduction

This chapter briefly describes the functions, capabilities, and benefits of the 8275 Model 416 High Performance Ethernet Workgroup Switch. This information helps you to plan for and use the 8275-416 in your network.

Product Overview

Fast Ethernet switching continues to evolve from high-end backbone applications to desktop switching applications. The 8275-416 provides a low cost and powerful Layer 2 switch solution. It is an attractive base switch offering with the following key functions:

- High performance, Layer 2, managed switch
- 16 base ports (10/100BASE-TX), expandable to 24 or 32 ports. The expansion can be any combination of the following optional feature modules:
 - 8-Port 10/100BASE-TX
 - 8-Port 100BASE-FX
- Robust management support; VT100 terminal interface, Web interface, SNMP
- Backplane performance 10 Giga-bits per second Ethernet switching
- Desktop and segment switching infrastructure
- Affordable migration to higher performance networks

Network administrators have a choice of three easy-to-use management methods: VT100 interface, Web-based, and Simple Network Management Protocol (SNMP). These management methods enable the network administrator to configure, manage, and control the 8275-416 locally or from anywhere on the network.

The Spanning Tree Protocol (STP) provides fault tolerance on the network.

8275-416 Functions

This section describes the functional support included in the 8275-416 :

- Layer 2 switching
- Management and user interface
- Security
- Reliability and serviceability
- Performance
- Flow Control
- Y2K

Layer 2 Switching

The 8275-416 is a frame-based Layer 2 Ethernet switch. In a Layer 2 switch, frame forwarding is based on MAC addresses. The 8275-416 supports the IEEE P802.1D (1990) standard.

802.3x Flow Control

The 8275-416 supports the 802.3x flow control, which, when enabled allows the transmission of data frames to be inhibited for a specified period of time. The default for 802.3x flow control is *Disabled*. 802.3x flow control is valid only when the port is in full duplex mode.

Broadcast Storm Recovery

The 8275-416 detects broadcast storms and automatically blocks broadcast traffic to minimize the impact of the broadcast storm on the rest of the network. You can enable or disable this function at a switch level. If broadcast storm recovery is enabled, each port will monitor incoming broadcast traffic. If the broadcast traffic exceeds 20 percent of the port speed, the broadcast traffic on this port is blocked until the broadcast traffic returns to 20 percent or below port speed. The default for broadcast storm recovery is *Disabled*.

Address Aging

An address recognized by the switch is removed from the port lookup tables after a period of time if no frames have been received from that address. The default value for the aging period is 300 seconds (5 minutes), but it can be changed by the user. The time values range from 10 seconds to 1000000 seconds.

If a port lookup table is full and a frame is received with a new address that needs to be added to the table, the frame is sent multicast.

Management and User Interfaces

The network administrator has a choice of these easy-to-use management methods:

- A VT100 terminal interface allows the network administrator to fully manage the 8275-416 using a standard terminal or terminal emulator connected over the network using Telnet or connected to the 8275-416's serial port (EIA 232).
"Chapter 2. Accessing the 8275-416" on page 11 describes how to access the 8275-416 using this interface and "Chapter 4. Using the Terminal Interface" on page 25 instructs you about using this interface.
- A Web-based interface enables you to manage the 8275-416 through standard Web browsers. There must be a physical path between the Web browser and the 8275-416 over the Ethernet network to use this method of connectivity.
"Chapter 2. Accessing the 8275-416" on page 11 describes how to access the 8275-416 using this interface and "Chapter 5. Using the Web Interface" on page 61 instructs you about using this interface.
- The 8275-416 has a Simple Network Management Protocol (SNMP) agent that the network administrator can access with a standard Network Manager. The following MIBs (Management Information Base) are supported:
 - MIB II (RFC 1213)
 - 8275-416 Enterprise MIB
 - RMON MIB (RFC 1757)
 - Bridge MIB (RFC 1493)
 - IEEE 802.3 Ethernet (RFC 1643)
- 8275-416 interoperates with the following SNMP Managers:
 - Any standard MIB Browser (SNMP V1)

- IBM Nways Manager for NT (V2.0 or later)
- IBM Nways Manager for HP-UX (V2.0 or later)
- IBM Nways Manager for AIX (V2.0 or later)

Security

User access security can be implemented using the following functions of the 8275-416 :

- User Accounts: The 8275-416 supports up to six accounts (one user with Read/Write status and five with Read Only status) for terminal interface and Web access. Access to the 8275-416 configuration panels is password protected. Only one user name with Read/Write status is allowed to be configured, which prevents potential conflicts in configuration changes. The default Read/Write user name is: **admin**, and the default password is blanks (no password). If you lose the password, contact your IBM service representative.
- SNMP read/write protection based on community name.

Reliability and Serviceability

The 8275-416 :

- Provides a comprehensive Power-On Self Test (POST) that ensures that all of its components are functioning correctly.
- Controls a seven-segment LED that allows you to follow the boot sequence.
- Allows you to download software upgrades using any of the management methods.
- Allows you to implement parallel paths for network traffic through the use of Spanning Tree Protocol (STP) which provides a level of fault tolerance and ensures that:
 - Redundant paths are disabled when the main paths are operational
 - Redundant paths are enabled if the main paths fail
- Allows you to configure a port to “see” traffic going into and out of another port on the 8275-416 (Port Mirroring).
- Provides statistics for all ports.

Performance

High performance, Layer 2 switching for the 8275-416 consists of:

- Switching for up to 32 ports
- Supporting up to 12 000 end stations
- Processing 64-bytes packets at the following rates:
 - 14 880 packets per second to 10 Mbps ports.
 - 148 800 packets per second to 100 Mbps ports
- Detecting broadcast storms and preventing them from impacting the network (Broadcast Storm Control).

Year 2000 (Y2K)

The 8275-416 is Y2K ready.

When used in accordance with its associated documentation, it is capable of correctly processing and/or receiving data within and between the 20th and 21st centuries - providing all other products (for example, hardware, software, and firmware) used with the 8275-416 properly exchange accurate data.

For additional information about Year 2000 related topics, visit:

<http://www.ibm.com/year2000>

Hardware

Cabling Requirements

Ethernet cables are *not* provided and must be separately purchased. You can order them through your IBM representative.

Table 1 shows cable type and length requirements. Cable requirements depend on the speed of the network. Cables and connecting hardware must meet the standards specified in the ANSI/TIA/EIA 856-A or CSA T529 standards.

Table 1. Ethernet Cable Requirements

Ethernet Type	Cable Requirements	Max. Cable Length
10BASE-T	Category 3, 4, 5, 100-ohm STP/UTP cable	100 m (328 ft)
100BASE-TX	Category 5, 100-ohm STP or UTP cable and connecting hardware	100 m (328 ft)
100BASE-FX	62.5 micron multimode fiber-optic cabling	2 km (6561 ft) at full duplex; 412 m (1352 ft) at half duplex

10/100BASE-TX

10BASE-T connections are MDX ports and operate correctly with standard Category 3, 4, 5, 100-ohm UTP or STP cable and connecting hardware, as specified in the ANSI/TIA/EIA 856-A or CSA T529 standards when connected to MDI ports. When connecting to other MDX ports, such as ports of other 8275-416 switches, you must use crossover cables.

Do not use telephone extension cables in 10/100BASE-TX networks. The wire pairs in those cables are not twisted and the cables do not meet other requirements for use in a 10BASE-T network.

For connections to 10/100BASE-TX networks, you can use only Category 5 STP or UTP cables.

100BASE-FX

For connection to 100BASE-FX networks, you can use only 62.5/125 MMF cabling with MTRJ connectors.

Front Panel

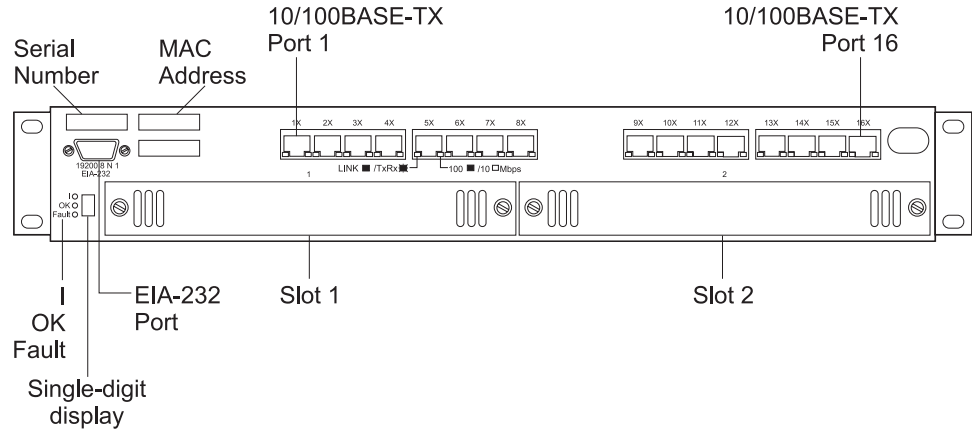

Figure 1. Front Panel of the 8275-416 .

8275-416 LEDs

8275-416 LEDs are located at the lower left corner of the front panel (left of the single-digit display) and are identified with a vertical bar (I), OK, and Fault. The LED for the vertical bar is Green, as is the OK LED; the Fault LED's color is amber. The states of the LEDs are on, off, or blinking, are explained later in this chapter.

Single-Digit Display

The single digit display is located at the lower left corner of the front panel as shown in Figure 2 on page 6. During diagnostics, the character displayed indicates the diagnostic test being executed. Once the 8275-416 is operational, the character displayed is its Unit ID.

Serial Port (EIA 232)

The serial port is a standard DB-9 male connector that provides an EIA-232 serial interface (sometimes referred to as the out-of-band management port). Use a null-modem serial cable when connecting to a workstation (see "Appendix C. Cable Pinout Diagrams" on page 79). Use a VT100 terminal emulator program to configure your terminal's attached COM port as follows:

- 19 200 baud
- 8 data bits
- 1 stop bit
- No parity
- Hardware flow control OFF

See "Chapter 2. Accessing the 8275-416" on page 11 for more information about connectivity.

Ethernet 10/100BASE-TX Ports

The 8275-416 has 16 Ethernet 10/100BASE-TX ports. Each port has two LEDs located at the lower right and left of the connector. Status indications of the Port LEDs are explained later in this chapter.

Feature Module Slots 1 and 2

These feature modules are available to expand port connections to your 8275-416 :

- 8-Port 10/100BASE-TX Ethernet Feature Module, IBM P/N 35L2355
- 8-Port 100BASE-FX Ethernet Feature Module, IBM P/N 35L2356

8275-416 Status LEDs

8275-416 Status LEDs are shown in Figure 2 and their indications are explained in the table that follows:

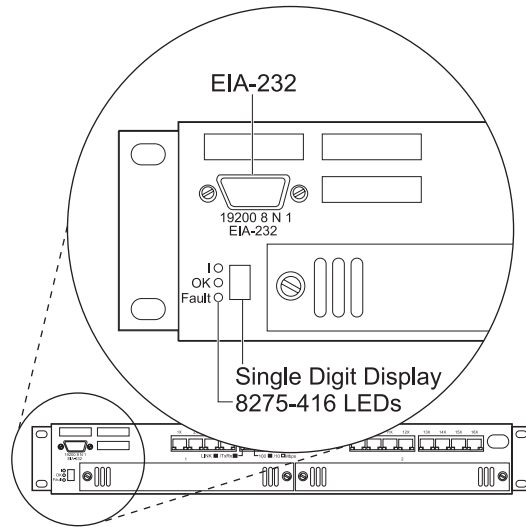

Figure 2. Status LEDs for the 8275-416 .

LED	Color	State	Explanation
I	Green	ON	There is power to the 8275-416 and the power supply is OK.
		OFF	There is no power is present, or there is a power supply failure.
OK	Green	ON	The 8275-416 is operational.
		OFF	The 8275-416 is not operational.
		Blinking	Operational code or configuration file transfer is in process.
Fault	Yellow	ON	Indicates a hardware fault.
		OFF	No hardware fault.
		Blinking	Diagnostics is in process.

Ethernet Port LEDs

Port LEDs on the 8275-416 and the 10/100BASE-TX Ethernet feature module are shown in Figure 3 and they are explained in the table that follows.

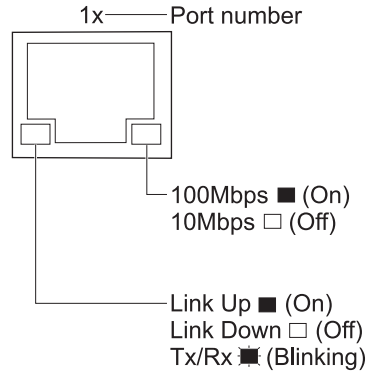

Figure 3. Port Status LEDs for the 8275-416 and the 10/100BASE-TX Ethernet Feature Module.

LED	Color	State	Explanation
Right Ethernet Port LED	Green	ON	Indicates a 100 Mbps port. This LED being On only has meaning if the link is up.
		OFF	Indicates a 10 Mbps port. This LED being Off only has meaning if the link is up.
Left Ethernet Port LED	Green	ON	Link is up.
		OFF	Link is down.
		Blinking	Transmitting (Tx) and Receiving (Rx) traffic.

Feature Module LEDs

Each feature module has an OK and a Fault LED located at the left side of the faceplate. The OK LED is Green and the Fault LED is amber. These LEDs are shown in Figure 4 and Figure 5 on page 9. They indicate the status of the feature module and are explained in the table that follows.

Status LEDs for the 10/100BASE-TX Ethernet Feature Module

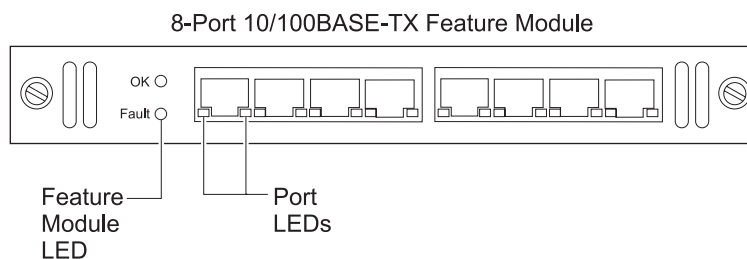

Figure 4. Status LEDs for the 10/100BASE-TX Ethernet Feature Module.

LED	Color	State	Explanation
OK	Green	ON	There is power to feature module.
		OFF	There is no power to feature module, no power to the 8275-416 , or the module has failed.
Fault	Yellow	ON	There is a module fault.
		OFF	There is no module fault.
Right Ethernet Port LED	Green	ON	Indicates a 100 Mbps port.
		OFF	Indicates a 10 Mbps port.
Left Ethernet Port LED	Green	ON	Link is up.
		OFF	Link is down.
		Blinking	Transmitting (Tx) and Receiving (Rx) traffic.

Status LEDs for the 100BASE-FX Ethernet Feature Module

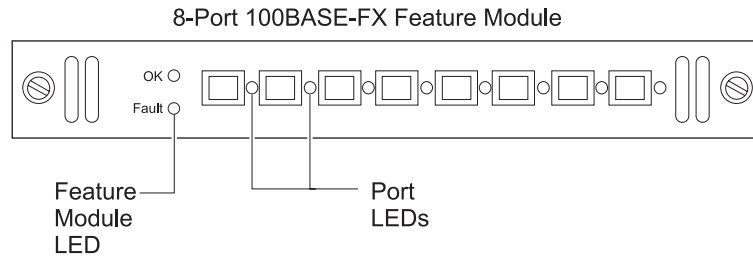

Figure 5. Status LEDs for the 100BASE-FX Ethernet Feature Module.

LED	Color	State	Explanation
OK	Green	ON	There is power to the feature module.
		OFF	There is no power to the feature module, no power to the 8275-416 or the module has failed.
Fault	Yellow	ON	There is a module fault.
		OFF	There is no hardware fault.
Port LED	Green	ON	Link is up.
		OFF	Link is down.
		Blinking	Transmitting (Tx) and receiving (Rx) traffic.

Physical Characteristics

Physical characteristics for the 8275-416 are summarized in the following table:

Characteristic	Specification
Physical Dimensions	<p>Height 63.0 mm (2.48 in.) 1.5 EIA rack units</p> <p>Width 440.0 mm (17.16 in.)</p> <p>Depth 355.6 mm (14 in.)</p>
Weight (estimate)	6.0 kg (13 lb)
Service Clearance	<p>Front Minimum of 15.3 mm (6 in.) for cooling, cables, and to view LEDs</p> <p>Sides Minimum of 50 mm (2 in.) for cooling</p> <p>Rear Minimum of 15.3 mm (6 in.) for cooling and power cord</p>

Characteristic	Specification
Operating Environment	<p data-bbox="951 254 1325 310">Operating Temperature 10° - 40° C (50° - 104° F)</p> <p data-bbox="951 327 1175 384">Operating Humidity 8% - 80%</p> <p data-bbox="951 401 1333 457">Storage Temperature 1° - 60° C (33.8° - 140° F)</p> <p data-bbox="951 474 1154 531">Storage Humidity 8% - 80%</p> <p data-bbox="951 548 1354 604">Shipment Temperature 40°C - 60°C (104°F - 140°F)</p> <p data-bbox="951 621 1170 678">Shipment Humidity 5% - 100%</p>

Chapter 2. Accessing the 8275-416

You have several ways to physically make connection (connectivity) and access the 8275-416 . Once connected, you will want to initially configure the IP information (either through the terminal interface or through DHCP or BootP), then choose which user interface you want to use to manage it. Therefore, all interfaces support configuring the 8275-416 and obtaining information from it, thus providing greater flexibility in how you manage your 8275-416 . This chapter explains the ways you can connect to your 8275-416 .

Connectivity Methods

There are two connectivity methods used to physically access the 8275-416 :

- Out-of-band connectivity, in which access to the 8275-416 is through the EIA 232 port.
- In-band connectivity, which is the ability to access the 8275-416 from a remote station using the Ethernet network

Table 2 outlines the user interfaces that are available depending on your method of connectivity.

Table 2. Connectivity Methods and Available User Interfaces

Connectivity Method	Available User Interface
Out-of-band	Terminal interface via the EIA 232 port (terminal directly attached, or remotely attached to modem)
In-Band	<ul style="list-style-type: none">• Terminal interface via Telnet• SNMP-based management interface• Web-based management interface

Out-of-Band Connectivity

Out-of-band connectivity lets you access your 8275-416 through the EIA 232 port. It can be either through a locally attached PC (personal computer) running VT100 terminal emulation software, or through a remotely attached PC running VT100 terminal emulation software.

Locally Attached Terminal

To establish out-of-band connectivity using a locally attached terminal, make the physical connections and set up using the following procedure:

1. Attach one end of a null-modem cable to the EIA 232 port of the 8275-416 as shown in Figure 6 on page 12, and the other end to the COM port of your PC (see "Appendix C. Cable Pinout Diagrams" on page 79).

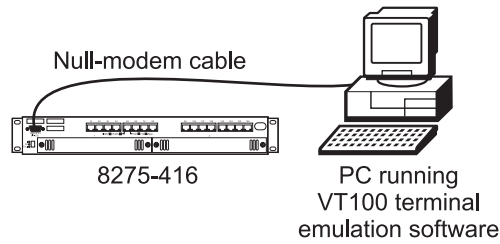

Figure 6. Out-of-Band Connectivity — Locally Attached Terminal

2.

Configure the VT100 terminal emulation application as follows:

- Baud rate: 19200
 - Parity: None
 - Data bits: 8
 - Stop bits: 1
 - Flow control: None
3. Log in to the terminal interface. The terminal interface requires you to log in with a user name and password. The user name must have Read/Write status. The default user name is: **admin**, and the password is blanks (no password).
 4. See “Appendix D. Interface Conventions for the Console” on page 83 for a description of terminal interface key definitions. You may need to configure your terminal emulation application to enable use of these keys.

Remotely Attached Terminal

To establish out-of-band connectivity using a remotely attached terminal, make the physical connections using the following procedure:

1. Unpack the modem and install it according to the manufacturer’s instructions.
2. Attach one of the serial cable (not provided) to the EIA 232 port of the 8275-416 and the other end to your modem as shown in Figure 7.

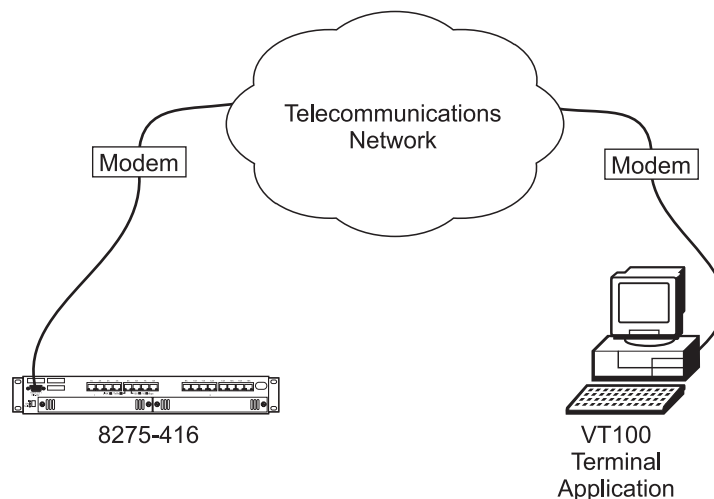

Figure 7. Out-of-Band Connectivity — Remotely Attached Terminal

3. Set up the modem that is attached to the 8275-416 by following these steps:

- a. Connect the other end of the cable to the modem.
 - b. Configure the modem to use the same settings as those on your 8275-416 .
 - Baud rate: 19200
 - Parity: None
 - Data bits: 8
 - Stop bits: 1
 - Flow control: None
 - c. Set up the remote modem and terminal.
 - d. Configuration command syntax varies from modem to modem. Make sure that the modem has the following characteristics:
 - Asynchronous mode
 - Disable modem response
 - Disable flow control (for example, AT \Q)
 - Disable echo (for example, AT Q1)
 - Autoanswer mode on second ring (for example, AT SO=2)
 - e. Setup the remote modem and terminal.
 - f. After configuring the modem, save the configuration.
 - g. Establish a modem link as described in the modem user documentation.
 - h. Log in to the terminal interface. The terminal interface requires you to log in with a user name and password. The user name must have Read/Write status. The default user name is: **admin**, and the password is blanks (no password).
 - i. See “Appendix D. Interface Conventions for the Console” on page 83 for a description of terminal interface key definitions. You may need to configure your terminal emulation application to enable use of these keys.
4. In order to use in-band connectivity, the 8275-416 must be configured with IP information (IP address, subnet mask, and default gateway). You can configure IP information initially by using either of these methods:
 - DHCP or BootP
 - Terminal interface via the EIA 232 port.
 5. To configure the IP information, see “Chapter 3. Configuring your 8275-416” on page 17 for details.

In-Band Connectivity - Telnet, Web, SNMP

Note: In order to use in-band connectivity, you must configure the 8275-416 with its IP information (IP address, subnet mask, and default gateway). See “Chapter 3. Configuring your 8275-416” on page 17 for configuring BootP or DHCP and IP information for your 8275-416 .

In-band connectivity allows access to the 8275-416 using the data network (as shown in Figure 8 on page 14).

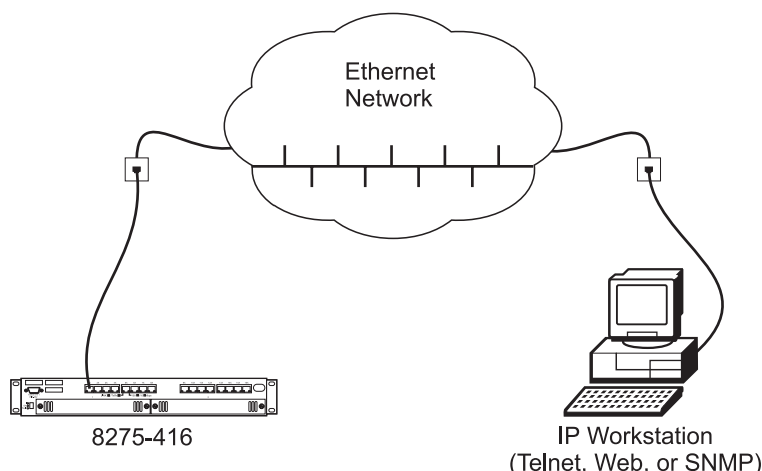

Figure 8. In-Band Connectivity

Terminal Interface - Telnet

Telnet console management can be performed through an Ethernet port (In-band connectivity). You must configure an Ethernet IP address before using Telnet console management (Refer to “Chapter 3. Configuring your 8275-416” on page 17 for initially configuring IP information for your 8275-416 .

You can use any Telnet application that emulates a VT100 terminal to establish a Telnet Console management session. Up to five concurrent Telnet sessions are supported. For security, the Telnet session can be automatically logged off after a certain time of inactivity. You configure the time of inactivity from 0 to 60 minutes; the default is 5 minutes.

The terminal interface is menu driven and can be used to manage the 8275-416 through the EIA 232 port or a Telnet session. For security, a log in userid and password is required. Multiple userids and associated passwords can be created. Two levels of access privileges are supported: read/write and read-only.

See “Appendix D. Interface Conventions for the Console” on page 83 for a description of the terminal keys. You may need to configure your terminal application to enable use of these keys.

See “Chapter 4. Using the Terminal Interface” on page 25 for a description of the terminal interface panels.

SNMP-Based Management Interface

The 8275-416 has an SNMP agent that supports SNMP Version 1 which allows it to be managed by any SNMP-based application (for example, Nways Campus Manager which supports the MIBs that the 8275-416 supports). MIBs supported by the 8275-416 are shown in Table 3.

Table 3. MIBs Supported by the 8275-416 .

MIBs Supported
MIB-II (RFC 1213)
Definitions of Managed Objects for Bridges (RFC 1493)

Table 3. MIBs Supported by the 8275-416 . (continued)

MIBs Supported

IEEE 802.3 Ethernet MIB (RFC 1643)

RMON MIB (RFC 1757)

IBM 8275-416 MIB

The SNMP-based application must specify the appropriate community name that the 8275-416 is configured to support. Real-time trap messages can be configured to be sent to designated trap receivers. All configuration information on the switch has read/write access via SNMP. All status information is also available via SNMP.

See “Chapter 4. Using the Terminal Interface” on page 25 for details about SNMP support for the 8275-416 .

Web-Based Management Interface

The 8275-416 has a Web server that supports HTTP 1.1 and HTML 3.2 or later. The Web browser must support HTTP 1.1 or HTML 3.2 or later.

The Web interface provides an interface to access and change 8275-416 parameters. Menus similar to those available through the terminal interface are also displayed by the Web browser. To access the 8275-416 from a Web browser, you must have configured the IP information for the 8275-416 . You will need a valid log in userid and password. The accepted userids and passwords are the same as those configured for the terminal interface.

See “Chapter 5. Using the Web Interface” on page 61 for starting and using the web interface.

Chapter 3. Configuring your 8275-416

After hardware installation, you must configure the IP address for your 8275-416 for it to be fully manageable in your network with the factory-default configuration. You might want to change some of the defaults at a later time.

First, you need to decide how you will access your 8275-416 . See “Chapter 2. Accessing the 8275-416” on page 11 for details about in-band and out-of-band connectivity. It is assumed that when you come to this chapter you will already have established connectivity.

Configuring IP information

IP information can be initially assigned either through:

- DHCP or BootP (the default), or
- Terminal interface through the EIA 232 serial port.

Your 8275-416 can be configured from remote locations using DHCP (Dynamic Host Configuration Protocol) or BootP. BootP (documented in RFC 951 and RFC 1542) is a bootstrap protocol used by a diskless workstation to learn its IP address, the location of its boot file, and the boot server name. The 8275-416 supports “reserved” or static DHCP, documented in RFC 1541.

If you are using DHCP or BootP, the DHCP or BootP server must be configured with the appropriate information for the 8275-416 . If you are not using BootP or DHCP, set the Network Configuration Protocol with a value of *None* to reduce network traffic.

When you use DHCP or BootP to get the 8275-416 's IP information, you configure the Network Configuration Protocol by selecting **Server Configuration Menu** from the Management Menu in the Terminal interface, and by defining the values as shown in Figure 9 on page 18:

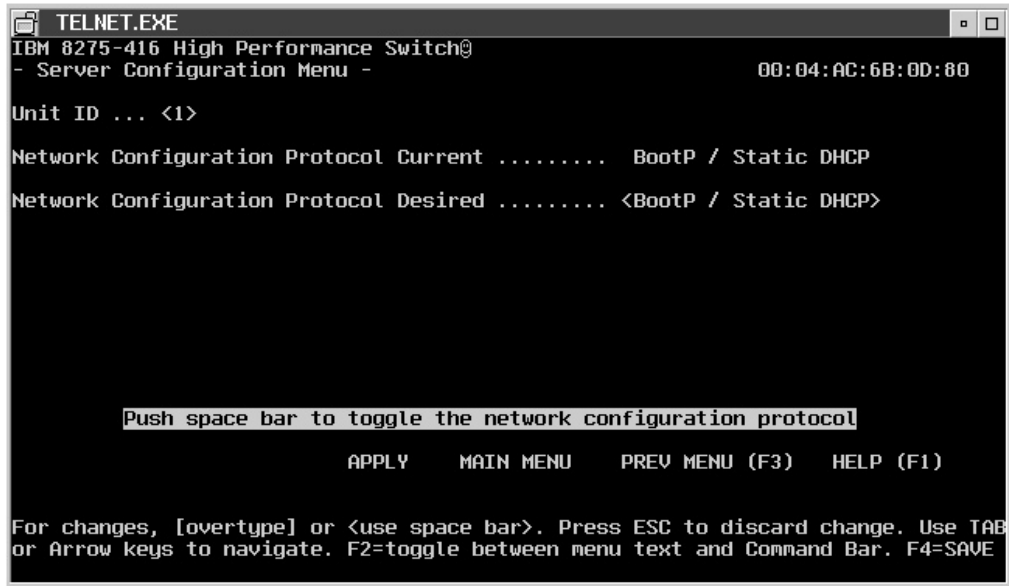

Figure 9. Configuring BootP/Static DHCP.

Network Configuration Protocol Desired

When you select BootP/Static DHCP (the default), the 8275-416 periodically sends requests to a BootP or DHCP server until a response is received.

None When you select None, you must manually configure the 8275-416 with the appropriate IP information.

To manually configure the IP information using the terminal interface, select **Network Connectivity Configuration Menu** from the Management Menu. Then, specify the information as described in the following text on the panel as shown in Figure 10

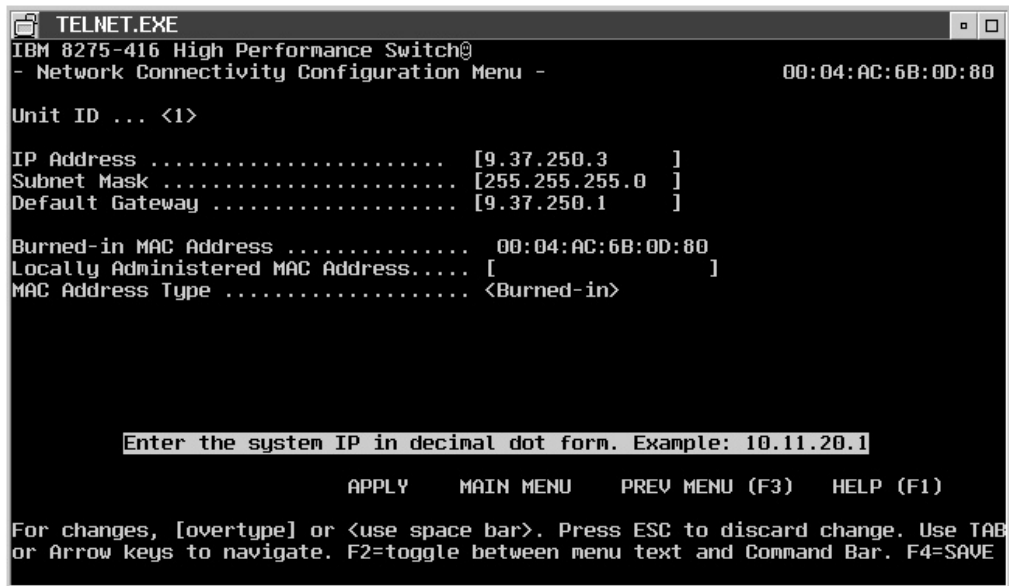

Figure 10. Configuring Network Connectivity (IP Information).

You must configure the following IP information to establish in-band connectivity (access through SNMP, Telnet, and Web interfaces) with the 8275-416 :

IP Address

Unique IP address of your 8275-416 . Each IP parameter is made up of four decimal numbers. The numbers range from 0 to 255. The default for all IP parameters are *zeros* (that is, 0.0.0.0).

Subnet Mask

Specifies the subnet mask for the LAN.

Default Gateway

If the 8275-416 is a node outside the IP range of the LAN.

Burned-in MAC Address

The burned-in MAC address is the default MAC address used.

Locally Administered MAC Address

A locally administered MAC address for the 8275-416 is an additional parameter that you can configure. The following rules apply when specifying a locally administered MAC address:

- Bit 6 of byte 0 (called the U/L bit) indicates whether the address is universally administered (B'0') or locally administered (B'1').
- Bit 7 of byte 0 (called the I/G bit) indicates whether the destination address is an individual address (B'0') or a group address (B'1').
- A locally administered address must have bit 6 On (B'1') and bit 7 Off (B'0').

MAC Address Type

The burned-in MAC address is the default MAC address type.

Concepts About Making Configuration Changes

This section provides key concepts about making configuration changes, getting the changes put into effect, and retaining the changes across a power cycle of the 8275-416 .

This chapter provides you specific information about making configuration changes using the Terminal interface, Web interface, and the SNMP interface.

Making Configuration Changes

Configuration changes are made by entering data for one or more items.

Error checking is done on the data entered to ensure that it is valued before it is processed, When the check is done and the result depends on the method used to initiate the change.

Configuration changes made by one user are also seen by other users when the same data is requested. Be aware that information displayed may be old data if the latest information is not requested prior to making any changes.

Processing Configuration Changes

Once you make a configuration change and it is accepted, the change is not put into effect until you issue an APPLY command. Apply makes the changes take

effect, but the changes are not automatically retained across a reset or power cycle. SAVE makes the changes take effect and also result in the changes being retained across a reset or power cycle.

Saving Configuration Changes Across a Reset or Power Cycle

In order for configuration changes to be retained across a reset or power cycle, you must issue a SAVE command.

Making Configuration Changes via the Terminal Interface

This section provides information about making configuration changes, getting the changes put into effect, and retaining the changes across a power cycle when using the Terminal Interface.

Making Configuration Changes

On the terminal interface menus, field entries that can be modified are surrounded by either square brackets ([]) or angle brackets (< >).

Square brackets identify an item that can be changed by typing in text. As soon as you begin typing, the current value of the field is erased and is replaced by the new text. In other words, no insert or overwrite modes can be performed in the field. You can use the following special keys while you are editing text fields:

- Arrow keys: Arrow keys are ignored when you are editing a text field. On a field where no modifications have been made, arrow keys are used to move the cursor to the appropriate field indicated by the direction of the arrow key pressed.
- Back Space: Removes a character in front of the cursor.
- Delete: Gives the same result as the Backspace.
- Enter: The text is accepted and the cursor moves to the next field. On a text field where no modifications have been made, Enter moves the cursor to the next field.
- ESC: Stops editing the field and restores the original data.
- Space Bar: May be an allowable key to enter text.
- Tab: Performs the same function as the Enter key.
- F4: Represents SAVE. Causes the configuration data to be saved and also applied if not already done.

Angle brackets identify an item that can be changed by selecting the desired option. The following special keys are used while selecting a configuration option:

- Arrow keys: The text is accepted and the cursor moves to the appropriate field indicated by the direction of the arrow key pressed. On a field where no modifications have been made, arrow key just moves the cursor to the appropriate field.
- Enter: The text is accepted and the cursor moves to the next field. On a field where no modifications have been made, Enter moves the cursor to the next field.
- ESC: Stops modifying the field and restores the original data.
- Space Bar: Displays the next possible value for this field. Used to cycle through the available options to select the desired value.
- Tab: Performs the same function as the Enter key.

- F4: Represents SAVE. Causes the configuration data to be saved and also applied if not already done.

When processing data entered in a text field, all leading and trailing whitespace characters are ignored (such as, space, Tab, ESC).

Once a configuration change is made and is accepted (the cursor is no longer on the field that was modified), the change is not put into effect until you issue an APPLY.

Applying (Processing) Configuration Changes

Note: To help you know when a configuration change needs to be applied, as soon as the first change is accepted, “APPLY” appears on the Command Bar.

When you select APPLY, the following occurs:

- All configuration changes associated with this panel are processed, that is, syntax checking is performed on the data, if applicable, and if that is successful, the configuration change is put into effect (processed).
- If invalid configuration data was entered (such as, data value is out of the supported range), none of the changes on the panel have been processed yet and an error message is displayed identifying the field containing the error. Invalid data errors are reported one field at a time. All configuration changes must be valid before any of the changes are processed.
- If the configuration change is processed successfully and UNSAVED DATA is not already displayed on the upper right corner of the panel, then UNSAVED DATA is displayed.
- APPLY no longer appears on the panel

If you make configuration changes and then exit a panel without applying the changes, your changes are lost. For example, the following results in losing any changes made on the panel:

- You make configuration changes on the current panel and you select any of the following commands:
 - MAIN MENU
 - PREV MENU
 - HELP MENU
 - NEXT PAGE
 - PREV PAGE
- You make configuration changes on the current panel and you select a different slot or port.

Note: Configuration changes are not automatically retained across a reset or a power cycle. To retain changes, you must issue a SAVE command as described in the following section.

Saving Configuration Changes Across a Reset or Power Cycle

For configuration changes to be retained across a reset or power cycle, you need to issue a SAVE command. Configuration changes made via the terminal interface can be permanently saved by either:

- Pressing the F4 (Save) key.

- Selecting **Save Applied Changes** on the System Utilities Menu.

As a reminder that there are configuration changes that need to be saved, “UNSAVED DATA” appears in the upper right corner of the panel. Once you issue a SAVE, the following happens:

1. SAVING DATA appears on the panel while the 8275-416 is in the process of permanently saving the current operational configuration data.
2. DATA SAVED appears on the panel when the 8275-416 completes saving the current operational configuration.
3. UNSAVED DATA no longer appears on the panel until the next configuration change is made.

If you issue a SAVE without previously having made an Apply for recently made configuration changes, the changes are automatically applied when the SAVE is issued.

If you initiate a reset of the switch without permanently saving previously made configuration changes, you are prompted with a message to continue without saving the configuration change.

Making Configuration Changes via the Web Interface

This section provides information on making configuration changes, getting the changes put into effect, and retaining the changes across a power cycle when using the Web Interface.

Making Configuration Changes

On the Web pages, field entries that can be modified are displayed in a box with a white background. Depending on the field being modified, you can modify the text by:

- Typing in the appropriate text over existing text (overwriting). If the data typed in is syntactically incorrect, the data entered is rejected and the original data is displayed.
- Selecting an option from one of the items displayed when the pull-down menu is selected. All items in a pull-down menu are syntactically correct.

Until the Apply or Save button is selected, you can restore any modified values to their original data by selecting the Undo button.

Processing Configuration Changes

Once the desired fields are modified, select the Apply button or Save button to process the changes. Apply makes the changes take effect but the changes are not automatically retained across a reset or power cycle. Save makes the changes take effect and also results in the changes being retained across a reset or power cycle.

Before the Web Browsers sends the request to the switch, the data for the fields changed are verified. If any field is invalid, an error message is displayed identifying the field that contains the error. Invalid data errors are reported one field at a time. All configuration changes must be valid before any of the changes are sent.

If you make configuration changes and then change the page without Applying or Saving the changes, the changes are not processed.

Saving Configuration Changes Across a Reset or Power Cycle

In order for configuration changes to be retained across a reset or power cycle, you must issue a SAVE command. Configuration changes can be permanently saved by either of these actions:

- Clicking the SAVE button.
- Going to the System Utilities Menu and selecting **Save All Applied Changes**.

Making Configuration Changes via SNMP

This section provides information on making configuration changes, getting the changes put into effect, and retaining the changes across a power cycle when using SNMP.

Making Configuration Changes

You make configuration changes via SNMP by issuing SNMP Set commands to MIB objects that the 8275-416 supports as read-write.

Processing Configuration Changes

When the SNMP Set is received, the 8275-416 checks the data to ensure that it is valid. If it is invalid, the SNMP error code BADVALUE is returned in the SNMP Set Response. Otherwise, the configuration change is processed and put into effect.

Saving Configuration Changes Across a Reset or Power Cycle

Configuration changes made via SNMP Set commands are not automatically retained across a reset or power cycle. To get these changes retained across a reset or power cycle, you must issue a SAVE. This can be done via the 8275-416 private MIB using swDevCtrlSaveConfiguration.

Chapter 4. Using the Terminal Interface

This chapter describes the 8275-416 terminal interface. To use the terminal interface it would be helpful to have skills and experience in using Ethernet networking products and to be familiar with networking concepts such as IP device management, bridging, switching, and collecting/evaluating trap and monitoring data

The terminal interface panels are automatically refreshed every few seconds to provide you with current information.

Note: The panels shown in this chapter are intended to be representative and should not be assumed to be entirely accurate because they are subject to change before shipment of the product.

Login Panel

The Login panel is the first panel displayed when initializing the terminal interface. Figure 11 shows the Login panel; you need an approved user name and password to log in.

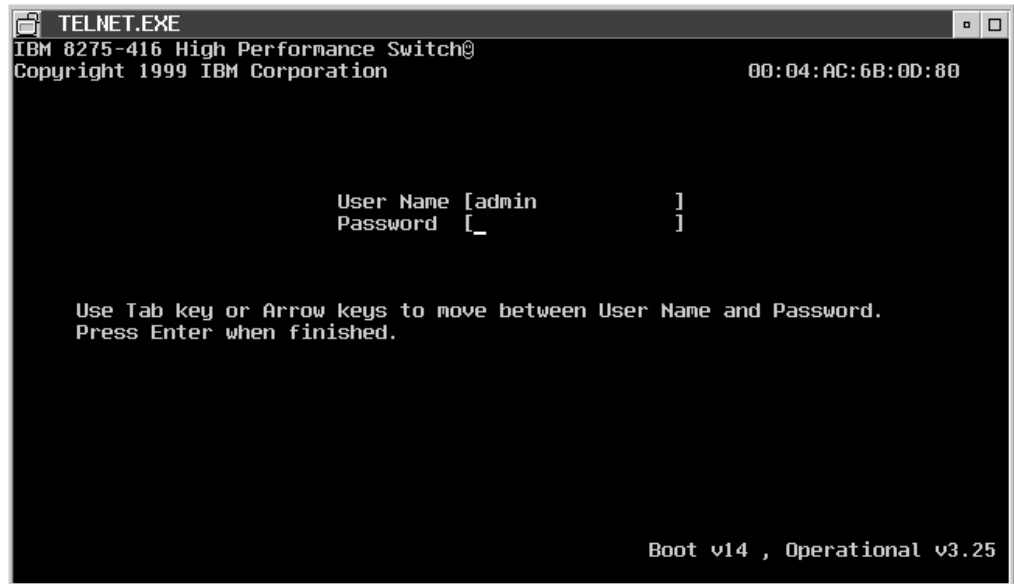

Figure 11. Log In Panel for Terminal Interface

- | | |
|------------------|---|
| User Name | Can be up to 8 alphanumeric characters in length. The value is not case sensitive. The default is admin for a read/write user, and guest is the default for a read only user. |
| Password | Can be up to 8 alphanumeric characters in length. The value is not case sensitive. The default is all blanks (blanks indicate no password). |

The terminal interface provides a way to logout. Either use the LOGOUT command on the Main Menu or from the Main Menu, select **System Utilities Menu**, then select **Logout**. When you have finished using the terminal interface, ensure you have saved all configuration changes before logging out.

The Main Menu

Following a successful login, the Main Menu appears (see Figure 12). Information following in this section is arranged in the order of topics on the Main Menu.

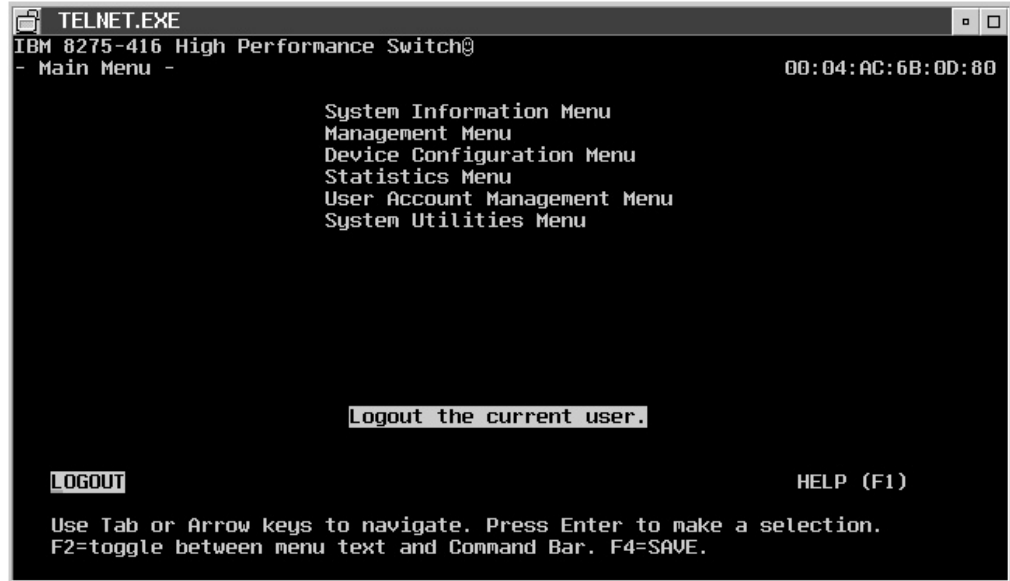

Figure 12. Main Menu for Terminal Interface

System Information Menu

Allows access to information that is maintained about the 8275-416 .

Management Menu

Contains selections associated with managing the 8275-416 .

Device Configuration

Contains selections associated with configuring the 8275-416 .

Statistics Menu

Contains selections for access to statistical data that is gathered for the 8275-416 .

User Account Management

Allows you to define users and passwords and their level of access.

System Utilities

Allows selection of the utilities available with the 8275-416 .

System Information

The 8275-416 manages information about the hardware and software version installed in the 8275-416 . System information contains read only and read/write fields. The read only fields are written when the 8275-416 is manufactured. Through configuration you can change only the read/write fields: *System Name*, *System Location* and *System Contact*. Changes to these fields must be saved to be effective. A reset is not necessary for the changes to be effective.

To access system information, select **System Information Menu** on the Main Menu. By selecting **Inventory Information Menu** and **System Description Menu**, you can view information about your 8275-416 .Figure 13 shows your system information options.

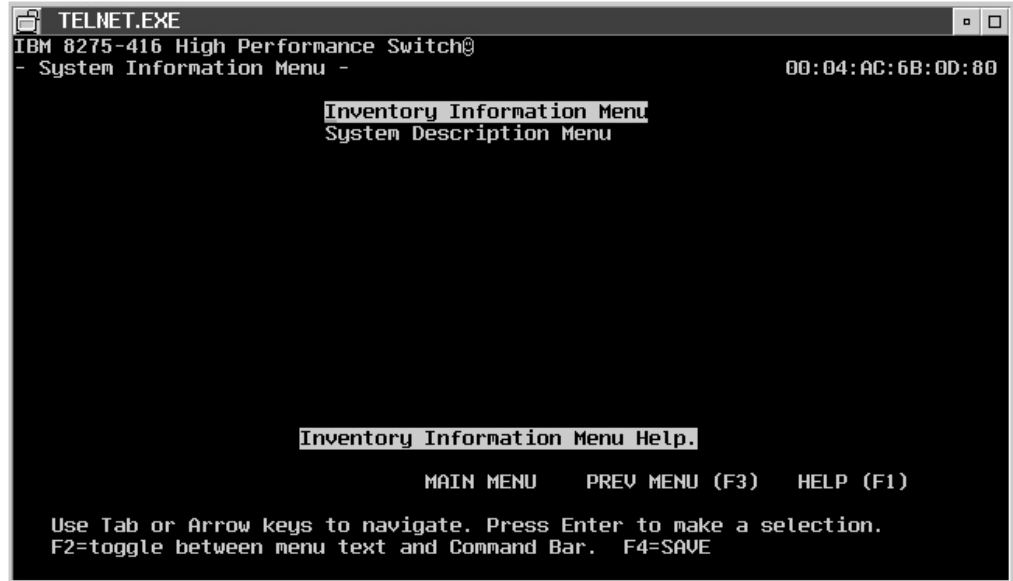

Figure 13. System Information Menu

Inventory Information

Figure 14 shows you inventory information available for your 8275-416 .

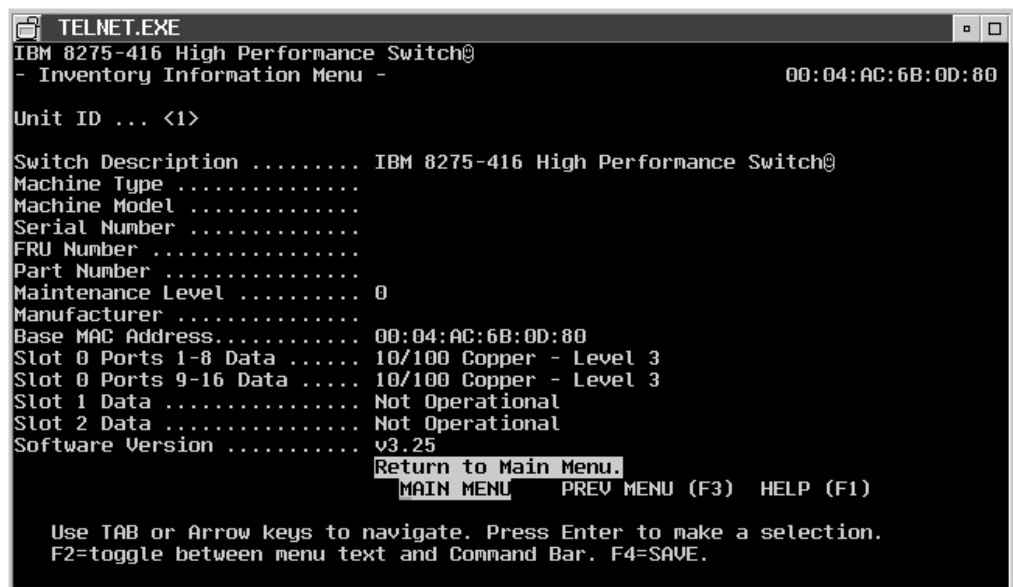
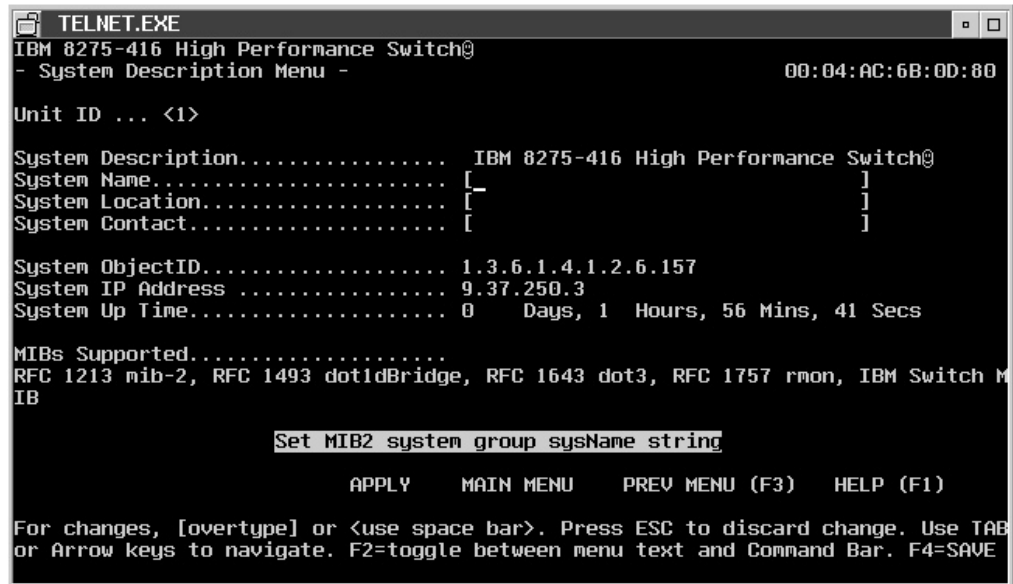

Figure 14. Inventory Information

System Description

Figure 15 shows you a system description for your 8275-416 .



```
TELNET.EXE
IBM 8275-416 High Performance Switch@
- System Description Menu -                                00:04:AC:6B:0D:80

Unit ID ... <1>

System Description..... IBM 8275-416 High Performance Switch@
System Name..... [ _ ]
System Location..... [ ]
System Contact..... [ ]

System ObjectID..... 1.3.6.1.4.1.2.6.157
System IP Address ..... 9.37.250.3
System Up Time..... 0 Days, 1 Hours, 56 Mins, 41 Secs

MIBs Supported.....
RFC 1213 mib-2, RFC 1493 dot1dBridge, RFC 1643 dot3, RFC 1757 rmon, IBM Switch M
IB

Set MIB2 system group sysName string

APPLY MAIN MENU PREV MENU (F3) HELP (F1)

For changes, [overtyp] or <use space bar>. Press ESC to discard change. Use TAB
or Arrow keys to navigate. F2=toggle between menu text and Command Bar. F4=SAVE
```

Figure 15. System Description

Management

Select **Management Menu** on the Main Menu (See Figure 16.) to use the management functions of the 8275-416 .

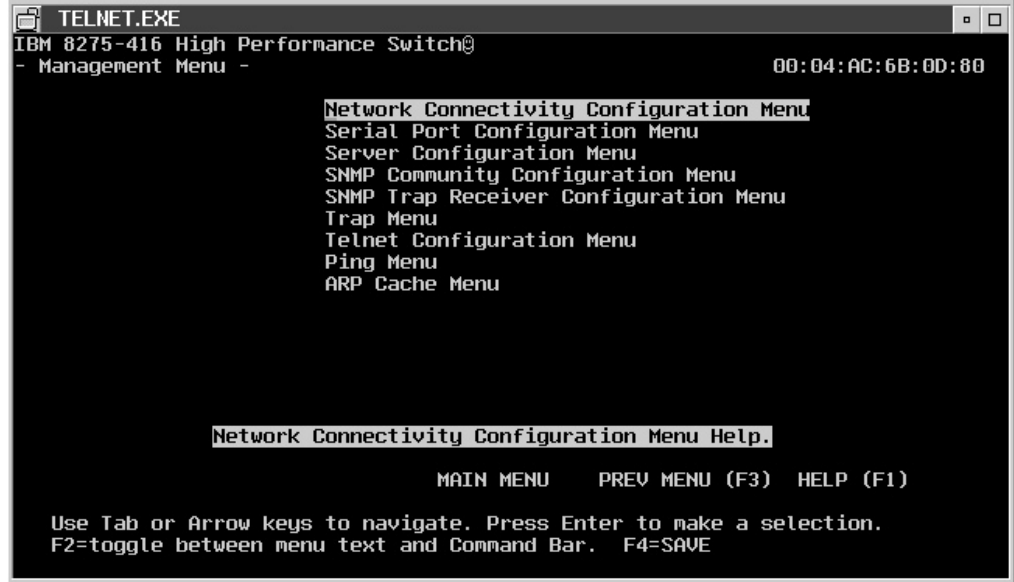

Figure 16. Management Menu

Configuring the 8275-416 for Network Connectivity

To configure the IP information using the terminal interface, select **Network Connectivity Configuration Menu** from the Management Menu. The Network Connectivity Configuration Menu appears as shown in Figure 17.

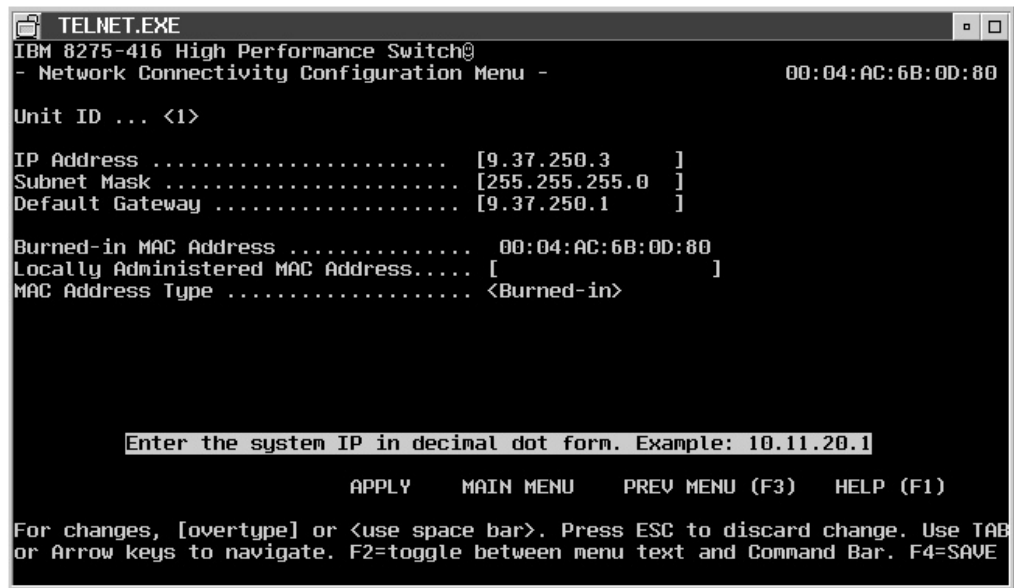

Figure 17. Network Connectivity Configuration

You must configure the following IP information to establish in-band connectivity to 8275-416 :

IP Address

Unique IP address for your 8275-416 . Each IP parameter is made up of four decimal numbers. The numbers range from 0 to 255. The default for all IP parameters are *zeros* (that is, 0.0.0.0).

Subnet Mask

Specifies the subnet mask for the LAN.

Default Gateway

If the 8275-416 is a node outside the IP range of the LAN.

Burned-in MAC Address

The burned-in MAC address is the default MAC address used.

Locally Administered MAC Address

A locally administered MAC address for the 8275-416 is an additional parameter that you can configure. The following rules apply when specifying a locally administered MAC address:

- Bit 6 of byte 0 (called the U/L bit) indicates whether the address is universally administered (B'0') or locally administered (B'1').
- Bit 7 of byte 0 (called the I/G bit) indicates whether the destination address is an individual address (B'0') or a group address (B'1').
- A locally administered address must have bit 6 On (B'1') and bit 7 Off (B'0').

MAC Address Type

The burned-in MAC address is the default MAC address type.

Configuring Serial Port

The 8275-416 allows you to access the 8275-416 through the serial EIA 232 port. This type of connectivity is called *Out-of-band connectivity*. Attachment can be direct local attach, or remote attached through a locally attached modem. See "Chapter 2. Accessing the 8275-416" on page 11 for descriptions of ways to access the 8275-416 .

On the Main Menu, select **Management Menu**. From the Management Menu, select **Serial Port Configuration Menu**. Figure 18 on page 31 shows the parameters to configure the serial EIA 232 port.

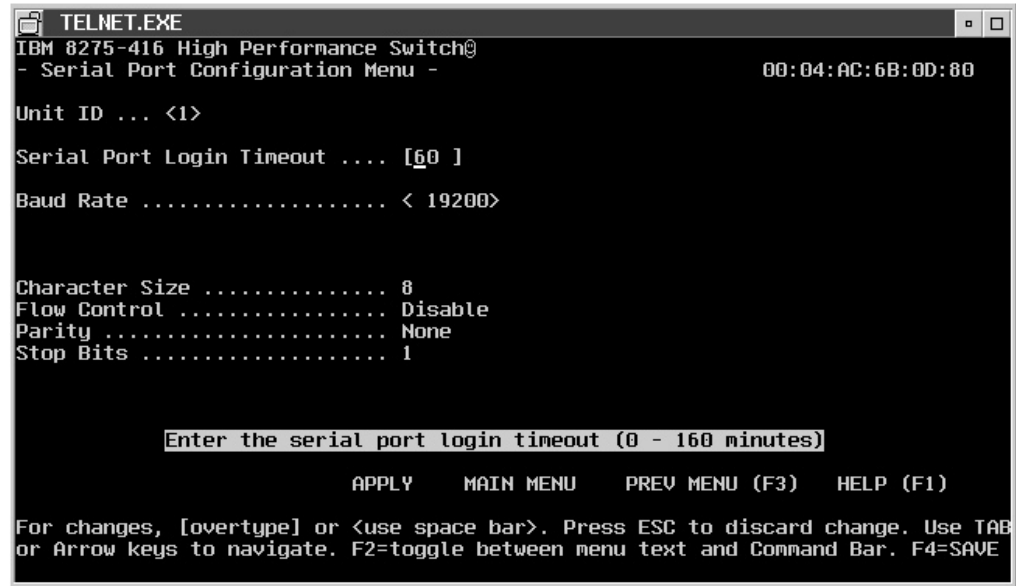

Figure 18. Serial Port Configuration

You specify Login Timeout and Baud Rate:

Serial Port Login Timeout:

Specifies the maximum connect time without console activity. The value is in a range from 0 to 160 minutes. A value of 0 indicates that a console can be connected indefinitely. The default value is 5 minutes.

Baud Rate :

Specifies the communication rate of the terminal interface. Values can be 1200, 2400, 4800, 9600, 19200, 38400, 57600, or 115200. The default value is 19200.

Configuring for DHCP or BootP Server

If you do not want to manually configure the 8275-416 with IP information, the 8275-416 can obtain the IP information from a BootP or DHCP server. When BootP or DHCP is enabled, the 8275-416 periodically send out requests until a response is received from either a DHCP or BootP server. The IP information in the BootP or DHCP response overlays any existing IP information in 8275-416 . The new IP information is not retained across a reset until a SAVE is issued.

DHCP

To configure static DHCP, you must specify an IP address that will be assigned to the 8275-416. This IP address is mapped to the 8275-416's MAC address. The static DHCP does not obtain an IP address from a pool of addresses on a DHCP server unless one is explicitly set up for a given MAC address. For example, In Windows NT, a reservation must be set up for the 8275-416's MAC address. It should be assigned an IP address from the pool of current addresses. The router, IP address, and subnet mask should all be configured for the 8275-416's MAC address. No other DHCP options are supported other than gateway/router address, IP address, subnet mask.

BootP

For BootP, the BootP server must have the appropriate information configured for the 8275-416 . A newly installed 8275-416 broadcast a BootP request over IP when it is powered on or reset. The BootP server, using information from its BOOTPTAB file, provides the 8275-416 with configuration information. In addition to obtaining the IP address and the subnet mask, the 8275-416 can attach to a configuration server to obtain a configuration file. The configuration file is an ASCII file containing 8275-416 commands. The commands are executed as soon as the configuration file is transferred via TFTP to the 8275-416 . The 8275-416 updates its configuration file with the information contained in the BootP message. The following is an example of a BOOTPTAB file entry containing configuration information for the 8275-416 :

```
8275_416_Switch_1:ht=ethernet:ha=0004ac6b0980:\
    ip=10.1.7.7:gw=10.1.1.1:\
    sm=255.255.255.0
```

```
8275_416_Switch_2:ht=ethernet:ha=0004ac6b09C0:\
    ip=10.1.7.8:gw=10.1.1.1:\
    sm=255.255.255.0
```

Where:

ht	hardware type
ha	host hardware address
ip	host IP address
gw	gateway address list
sm	subnet mask

Configuration information obtained from the BootP server is not saved unless you issue the SAVE command. Next, configure the Network Configuration Protocol.

Configuring 8275-416 for DHCP or BootP Server

If you are using DHCP or BootP, the DHCP or BootP server must be configured with the appropriate information for the 8275-416 .

If you are not using BootP or DHCP, set the Network Configuration Protocol with a value of *None* to reduce network traffic.

When you use DHCP or BootP to get the 8275-416 's IP information, you configure the Network Configuration Protocol by selecting **Server Configuration Menu** from the Management Menu. The Server Configuration Menu is shown in Figure 19 on page 33.

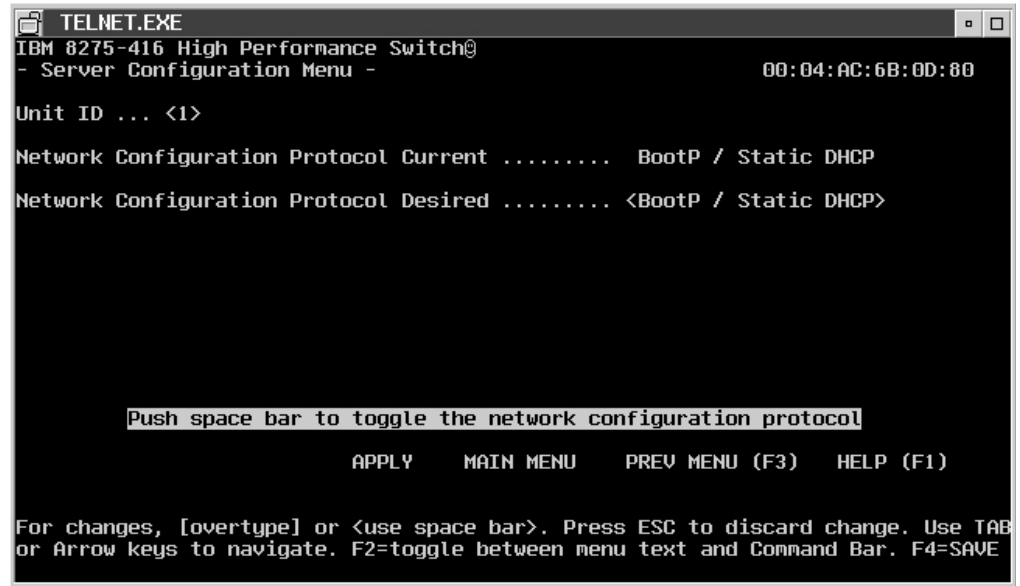

Figure 19. Server Configuration

Define one of the following values:

Unit ID

Up to 8 alphanumeric characters which identifies the 8275-416 .

Network Configuration Protocol Desired

When you select BootP/Static DHCP (the default), the 8275-416 periodically sends requests to a BootP or DHCP server until a response is received. If you are not using BOOTP or DHCP, set the Network Configuration Protocol with a value of *None* to reduce network traffic.

Configuring SNMP

The 8275-416 has an SNMP agent that complies with SNMP Version 1 (SNMPV1). For more about the SNMP specification, see the appropriate SNMP RFCs. The SNMP agent sends traps through TCP/IP to an external SNMP manager based on your SNMP configuration. SNMP configuration for the 8275-416 includes configuring the trap receiver and SNMP community parameters, which are described in the following text.

Configuring the SNMP Community

The SNMP agent must be configured with a community name for the 8275-416 . A community name is a name associated with the 8275-416 and with a set of SNMP managers allowed to manage it with a specified privileged level. You can add, change or delete communities. The 8275-416 does not have to be reset for changes to take effect. Up to six communities are simultaneously supported.

To configure your SNMP communities, select **SNMP Community Configuration Menu** from the Management Menu. Figure 20 on page 34 shows SNMP community information you need to specify.

```

TELNET.EXE
IBM 8275-416 High Performance Switch@
- SNMP Community Configuration Menu -                                00:04:AC:6B:0D:80

Unit ID ... <1>

SNMP Community Name  Client IP Address  Client IP Mask  Access Mode  Status
-----
[public      ]  [-- undefined --]  [-- undefined --]  <Read Only >  <Enable >
[private    ]  [-- undefined --]  [-- undefined --]  <Read/Write>  <Enable >
[<unused>   ]  [-- undefined --]  [-- undefined --]  <Read Only >  <Delete >
[<unused>   ]  [-- undefined --]  [-- undefined --]  <Read Only >  <Delete >
[<unused>   ]  [-- undefined --]  [-- undefined --]  <Read Only >  <Delete >
[<unused>   ]  [-- undefined --]  [-- undefined --]  <Read Only >  <Delete >

Enter the SNMP community name

APPLY  MAIN MENU  PREV MENU (F3)  HELP (F1)

For changes, [overtime] or <use space bar>. Press ESC to discard change. Use TAB
or Arrow keys to navigate. F2=toggle between menu text and Command Bar. F4=SAVE

```

Figure 20. SNMP Community Configuration

SNMP Community Name:

Name identifies each SNMP community and can be a string up to 32 characters. A *public* community means users have read only access. A *private* community is for users who have read/write access. Two communities have default values. The default names are Public and Private. You can replace these default community names with unique identifiers for each community. The default value for the remaining four community names are blank.

Access Mode:

This value can be read only or read/write. A community with a read only access allows for 8275-416 information to be displayed. A community with a read/write access allows for configuration changes to be made and for information to be displayed.

Client IP Address

This attribute is an IP address (or portion thereof) from which this device will accept SNMP packets with the associated community. The requesting entity's IP address is combined with the Client IP Mask before being compared to the Client Ip Address. Note: If the Client IP Mask is set to 0.0.0.0, a Client IP Address of 0.0.0.0 matches all IP addresses.

Client IP Mask

This attribute is a mask to be combined with the requesting entity's IP address before comparison with Client IP Address. If the result matches with Client IP Address then the address is an authenticated IP address . For example, if the Client IP Address is 9.47.128.0 and the corresponding Client Ip Mask is 255.255.255.0, a range of incoming IP addresses would match, ie the incoming IP addresses could be a value in the following range: 9.47.128.0 - 9.47.128.255.

Status:

This attribute has the following values: Enable, Disable and Delete on the Terminal and Web interface and Active, Inactive, and Delete via SNMP. A status value of Enable/Active means that the community is active, allowing SNMP managers associated using this community to manage the

Roadrunner according to its access right. A status value of Disable/Inactive means that the community is not active; no SNMP requests using this community will be accepted. In this case the SNMP manager associated with this community cannot manage the 8275-416 until the Status is changed back to Enable/Active. A status value of Delete means that this name will be removed from the table. The default Status values for the default private and public community names are both Enable/Active. The default value is Disable/Inactive for remaining four communities.

Configuring the Trap Receiver

Trap messages are sent across a network to an SNMP Network Manager. These messages alert the manager to events occurring within the 8275-416 or on the network. Up to six simultaneous Trap Receivers are supported.

To configure Trap Receivers, select **SNMP Trap Receiver Configuration Menu** on the Management Menu. Figure 21 shows the parameters you need to specify.

```

TELNET.EXE
IBM 8275-416 High Performance Switch@
- SNMP Trap Receiver Configuration Menu -          00:04:AC:6B:0D:80

Unit ID ... <1>

SNMP Community Name      IP Address      Status
-----
[public ] [-- undefined --] <Invalid >
[public ] [-- undefined --] <Invalid >
[public ] [-- undefined --] <Invalid >
[public ] [-- undefined --] <Invalid >
[public ] [-- undefined --] <Invalid >
[public ] [-- undefined --] <Invalid >

Enter the SNMP community name

APPLY      MAIN MENU  PREV MENU (F3)  HELP (F1)

For changes, [overtyping] or <use space bar>. Press ESC to discard change. Use TAB
or Arrow keys to navigate. F2=toggle between menu text and Command Bar. F4=SAVE

```

Figure 21. SNMP Trap Receiver Configuration

Trap Receiver parameters are:

SNMP Community Name:

The SNMP community name of the remote network manager. The name can be up to 32 characters. The default value is “blank”.

IP Address:

Each IP address parameters is four decimal numbers. The numbers range from 0 to 255. The default IP address is 0.0.0.0.

Status:

The status for trap receivers can be Enabled, Disabled, or Deleted. Trap receivers with enabled status are active and the SNMP agent sends traps to them. Trap receivers with disable status are inactive the SNMP agent does not send traps to them. Trap receivers with a deleted status are removed from the table.

Configuring Traps

Configuring Trap Conditions

You can optionally configure which traps that the 8275-416 should generate. You do this by selecting a status for the trap condition, that is, if it is either enabled or disabled. If a trap condition is enabled and the condition is detected, 8275-416's SNMP agent sends the trap to all enabled trap receivers. Otherwise, no condition is detected and no trap is sent. The default Status value for all Trap Conditions is Enabled. The 8275-416 does not have to be reset to implement the changes. Warm start and cold start traps are always generated; there are no associated trap conditions.

To configure trap conditions, select **Trap Menu** from the Management Menu, the select you condition to configure from the Trap Menu. Your choices are viewing the trap log, enabling/disabling trap flags, and checking the trap log status.

Figure 22 shows the trap flags that you can set.

```
TELNET.EXE
IBM 8275-416 High Performance Switch@
- Trap Flags Configuration Menu -                                00:04:AC:6B:0D:80

Unit ID ... <1>

Authentication Flag ..... <Enable >
Link Up/Down Flag ..... <Enable >
Multiple Users Flag ..... <Enable >
Spanning Tree Flag ..... <Enable >

Push space bar to enable/disable Authentication Failure trap flag

APPLY      MAIN MENU  PREV MENU (F3)  HELP (F1)

For changes, [overtyp] or <use space bar>. Press ESC to discard change. Use TAB
or Arrow keys to navigate. F2=toggle between menu text and Command Bar. F4=SAVE
```

Figure 22. Trap Flags Configuration

The following are the definitions of the Trap Conditions:

Authentication Failure:

Enable/Disable authentication traps.

Link Up/Down:

Enable/Disable Link Up/Link Down traps.

Multiple Users:

Enable/Disable Multiple User traps.

Spanning Tree:

Enable/Disable Spanning Tree traps.

Trap Log

The 8275-416 maintains a Trap Log; it contains a maximum of 64 entries which wrap. Select **Trap Menu** from the Management Menu, then select **Trap Log Menu** from the Trap Menu. Figure 23 shows the entries in the trap log.

```
TELNET.EXE
IBM 8275-416 High Performance Switch@
- Trap Log Menu -                                00:04:AC:6B:0D:80
Unit ID ... <1>                                  Page 1 of 1
-----
Log      System Up Time      Trap
-----
6        0 days 01:54:47      Multiple Users: Unit: 1
5        0 days 01:54:08      Multiple Users: Unit: 1
4        0 days 00:31:14      Link Down: Unit: 1 Slot: 0 Port: 4
3        0 days 00:31:11      Link Up: Unit: 1 Slot: 0 Port: 4
2        0 days 00:00:11      Link Up: Unit: 1 Slot: 0 Port: 1
1        0 days 00:00:10      Cold Start: Unit: 1

Go to the Next Page.

NEXT PAGE    PREV PAGE    MAIN MENU    PREV MENU (F3)  HELP (F1)

Use Tab or Arrow keys to navigate. Press Enter to make a selection.
F2=toggle between menu text and Command Bar. F4=SAVE
```

Figure 23. Trap Log

Each entry contains:

System Up Time:

This entry shows how long the system has been continuously operational.

Trap: This entry is the name (a 16-byte character string) of the trap condition; which are:

- Warm Start
- Cold Start
- Authentication Failure
- Link Up
- Link Down
- Multiple Users
- New Spanning Tree Root
- Spanning Tree Topology Change

The following are valid operations of Trap Log:

Display:

The newest to oldest traps are listed. Use this operation to view all Trap Log entries.

Clear: This operation empties Trap Log. Use this operation to clear the Trap Log.

Trap Log information is not retained across a switch reset.

Checking Trap Log Status

By selecting **Trap Menu** from the Management Menu, then selecting **Trap Log Status Menu** from the Trap Menu, you can check the status of how many traps that have been generated. You can choose to clear the trap log on this panel (see Figure 24).

```
TELNET.EXE
IBM 8275-416 High Performance Switch@
- Trap Log Status Menu -                                00:04:AC:6B:0D:80

Unit ID ... <1>

Number of Traps Since Last Reset ..... 6
Number of Traps Since Log Last Displayed .... 0

Clear Trap Log ..... <No >

Select <yes> and APPLY to clear the trap log
APPLY      MAIN MENU  PREV MENU (F3)  HELP (F1)

For changes, [overtime] or <use space bar>. Press ESC to discard change. Use TAB
or Arrow keys to navigate. F2=toggle between menu text and Command Bar. F4=SAVE
```

Figure 24. Trap Log Status

Configuring Telnet

You can manage the 8275-416 remotely using a Telnet connection. “Chapter 2. Accessing the 8275-416” on page 11 describes setting up a Telnet connection. To configure for Telnet, select **Management Menu** from the Main Menu, then from the Management Menu, select **Telnet Configuration Menu** (see Figure 25 on page 39).

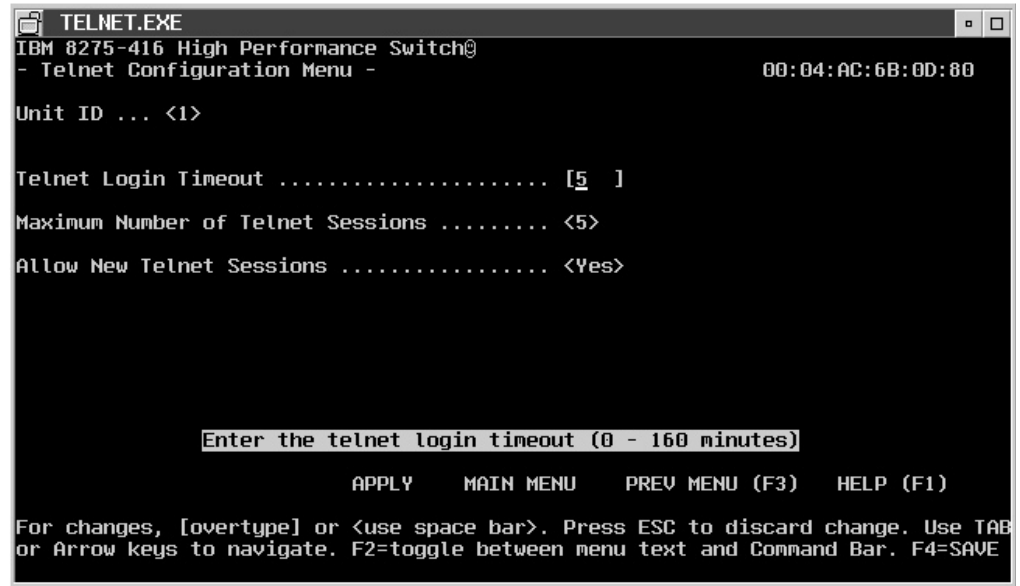

Figure 25. Telnet Configuration

The following parameters are for configuring a Telnet session with the 8275-416 :

Telnet Login Timeout

A session is active as long as the session has not remained idle for the value set. Specify a decimal value from 0 to 160 minutes. A value of 0 indicates that a Telnet session remains active indefinitely. The default is 5 minutes.

Maximum Number of Telnet Sessions

Specify a decimal value from 0 to 5. If the value is 0, no telnet session can be established. The default value is 5.

Allow New Telnet Sessions:

Specify a value of Yes or No. A value of Yes means that new telnet sessions will be establish until there are no more sessions available. A value of No means that no new telnet session are to be established. If there are no sessions at the moment, and you indicate that the value is to be applied or saved, then no Telnet connections are allowed. Any already established session remains active until the session is ended or an abnormal network error ends it. The default value is Yes.

Ping

The 8275-416 provides a Ping utility that can be used to check connectivity between devices in a network. To use ping, the 8275-416 must be configured correctly for network (in-band) connectivity. The source and target devices must have the ping utility enabled and running on top of TCP/IP. The 8275-416 can be pinged from any IP workstation (as long as there is a physical path between the 8275-416 and the workstation). The terminal interface allows you to send one ping, three pings or a continuous ping to the target station.

To use Ping, select **Management Menu** from the Main Menu. Then select **Ping Menu** from the Management Menu (see Figure 26 on page 40).

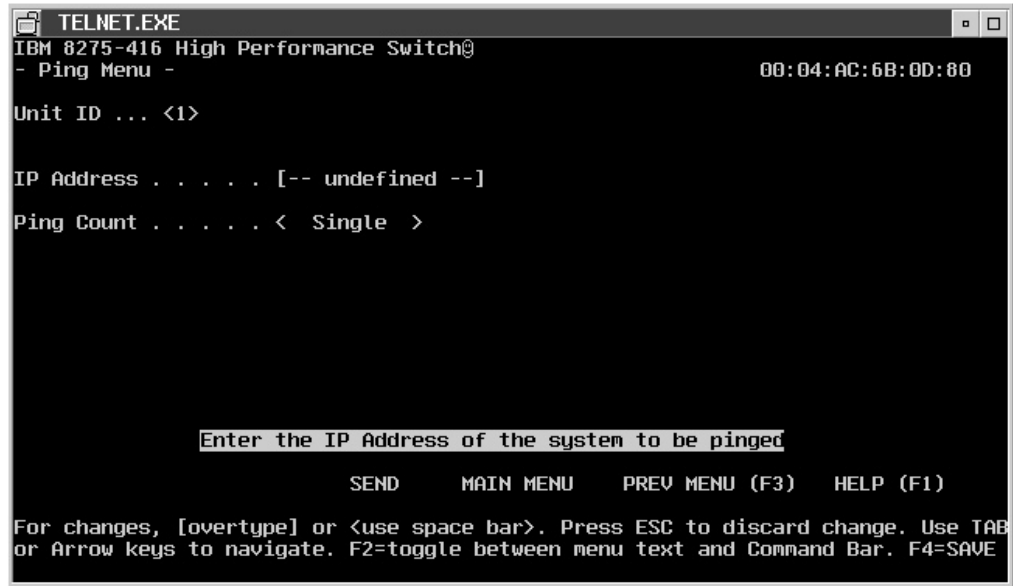

Figure 26. Ping

You must supply this information:

IP Address:

The IP address of the target station. The value is 4 decimal bytes ranging from 0 to 255. The default is 0.0.0.0.

Ping Count:

You can select one of these values; the default value is single:

- Single — one ping is sent to target station.
- Multiple — three pings are sent to the target station.
- Continuous — a ping is sent every second.

Command:

Send is the only command. To stop sending pings, press F3 (PREV MENU) or select the Main Menu when sending continuous pings.

ARP Cache

Select **Management Menu** from the Main Menu. Then, select **ARP Cache Menu** from the Management Menu to displays the ARP cache for the 8275-416 .

This is used to check connectivity between the 8275-416 and other devices. The ARP cache identifies the MAC address of the IP stations communicating with the 8275-416 . SeeFigure 27 on page 41 for ARP Cache information.

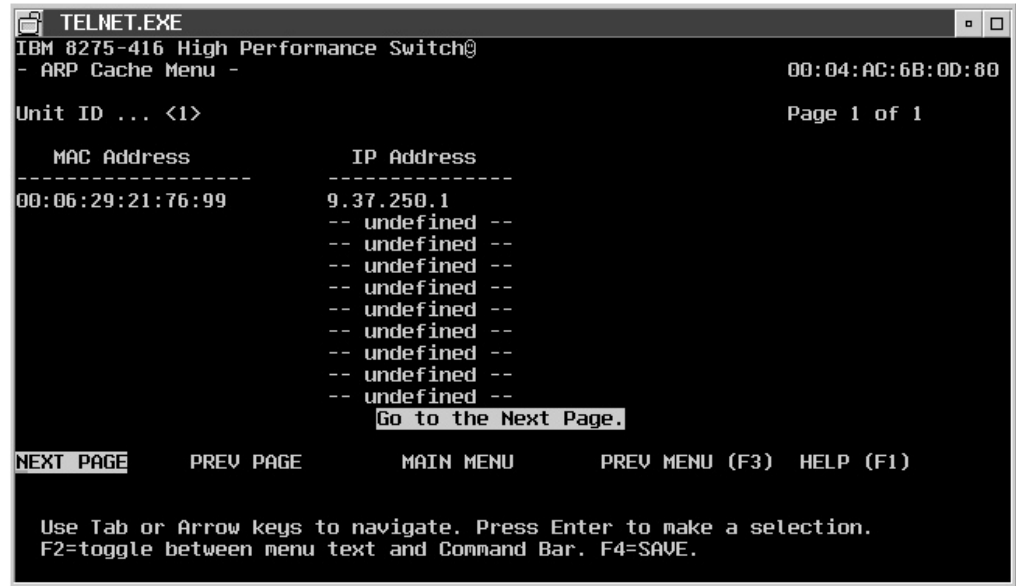



Figure 27. ARP Cache

Device Configuration

To configure the 8275-416, select **Device Configuration Menu** on the Main Menu. Figure 28 shows your options.



```
TELNET.EXE
IBM 8275-416 High Performance Switch@
- Device Configuration Menu -                                00:04:AC:6B:0D:80

Switch Configuration Menu
Port Configuration Menu
Port Monitoring Menu
Spanning Tree Switch Configuration/Status Menu
Spanning Tree Port Configuration/Status Menu
Broadcast Storm Recovery Menu
802.3x Flow Control Menu

Switch Configuration Menu Help

MAIN MENU    PREV MENU (F3)  HELP (F1)

Use Tab or Arrow keys to navigate. Press Enter to make a selection.
F2=toggle between menu text and Command Bar. F4=SAVE.
```

Figure 28. Device Configuration

Configuring the 8275-416

Address Aging Timeout

The 8275-416 allows you to set a time after which its address will timeout; the address aging timeout. This value can be set by selecting Device Configuration Menu from the Main Menu, then selecting Switch Configuration Menu (see Figure 29 on page 43).

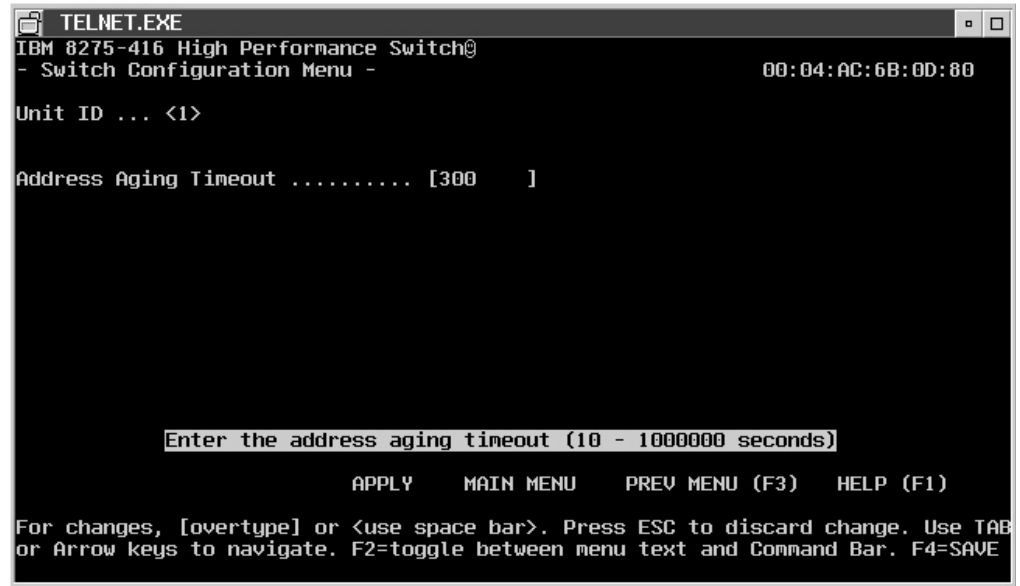

Figure 29. Switch Configuration

The value you specify is:

Address Aging Timeout

The value can be in a range from 0 — 1,000,000 (seconds). The default is 300 (seconds).

Configuring Ports

The 8275-416 is shipped from the factory with default port settings that allow it to automatically determine the port type and speed.

See “Chapter 3. Configuring your 8275-416” on page 17 for details about making and saving configuration changes.

You can configure the ports by selecting **Device Configuration Menu** from the Main Menu, then by selecting **Port Configuration Menu** from the Device Configuration Menu. (see Figure 30 on page 44).

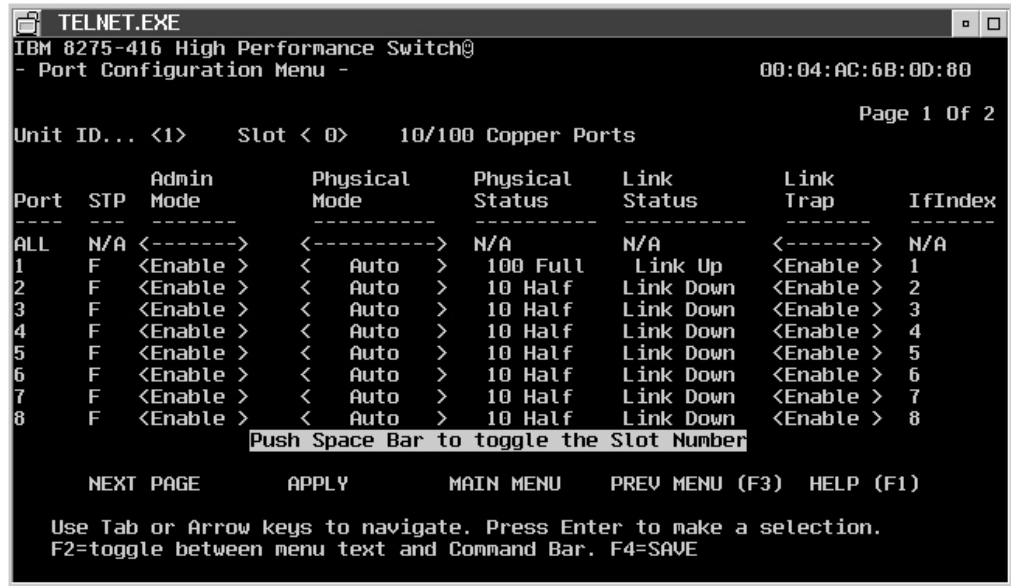

Figure 30. Port Configuration

You can select or change the following values:

Slot The 16 base ports are associated with slot 0. A feature module in Slot 1 or Slot 2 have ports 1-8 associated with them.

Port Indicates the port number. Ports are identified by a slot and port number. The slot and port number are separated by a period (.). The base set of ports are considered to be on slot 0. The feature slots are Slot 1 and Slot 2. For each slot, the ports are numbered 1 to 8. Since there are 16 base ports, each 8275-416 has ports 0.1 to 0.16. Ports on a feature module located in Slot 1 are numbered 1.1 to 1.8, and ports on a feature module in Slot 2 are numbered 2.1. to 2.8.

Admin Mode

This value indicates if the port is Enabled or Disabled. The default for all ports is Enabled. At start-up, each port is reset and the spanning tree state reported is Disabled until the Link is Up. The 8275-416 ensures that the station is at the correct speed and duplex setting, turns on the port LED that indicates Link is Up. Once the Link is up, the port transmits and receives frames and participates in the spanning tree protocol as defined by the spanning tree configuration.

Physical Mode

The value of Auto (autodetect) is valid only for 10/100BASE-TX ports.

Link Trap

This value can be Enabled or Disabled. It allows you to enable traps by port.

read only fields

The read only fields are:

- STP- indicates if the port participates in Spanning Tree Protocol (STP)
- Physical Status - indicates if port is full-duplex or half-duplex.
- Link Status - indicates if the port link is up or down.
- IfIndex - When using SNMP, the interface index (ifIndex) is sometimes used to identify the specific interface being addressed. On a 8275-416 ,

each Ethernet port is an interface and so is the IP Agent being used for managing it (which is also referred to as the Management Interface).

- The value returned for ifNumber in the MIB-II Interface table does not include the Management Interface (that is, the value of ifNumber only reflects the number of ports in the switch). If there are 32 ports, ifNumber will incorrectly be 32 instead of being 33.
- Port ifIndex Values - The ifIndex values for the 8275-416 ports start with 1 and increment by 1 for each port physically in the box. Each ifIndex value maps, one for one, with an Ethernet port.
- Example scenarios:
 - if there are 32 ports (16 base ports, 8 ports in slot 1, 8 ports in slot 2)
 - ifIndex 1 is slot 0, port1
 - ifIndex 9 is slot 0, port 9
 - ifIndex 17 is slot 1, port 1
 - ifIndex 25 is slot 2, port 1
 - if there are 24 ports (16 base ports, 8 ports in slot 2)
 - ifIndex 1 is slot 0, port1
 - ifIndex 9 is slot 0, port 9
 - ifIndex 17 is slot 2, port 1

The Management Interface always has an ifIndex of 1000.

Port MAC Address

Each port is automatically configured with a burned-in MAC address. This address is used as the source address of spanning tree frames and may be used in 802.3x PAUSE frames for the 8275-416 .

Configuring Port Monitoring

Any of the Ethernet ports can be selected as a probe to monitor forwarded traffic (not local traffic) with an external network analyzer. The selected probe port can monitor (mirror) traffic from one port.

From the Main Menu, select **Device Configuration Menu**. Then, select **Port Monitoring Menu** from the Device Configuration Menu. (See Figure 31 on page 46.)

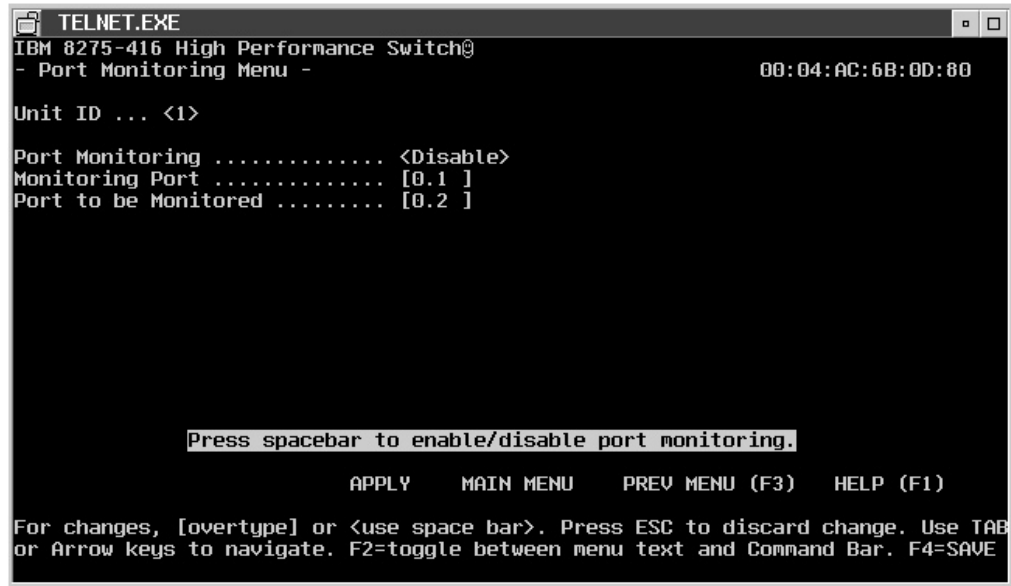

Figure 31. Port Monitoring

Specify values for the following parameters:

Port Monitoring:

Used to *Enable* or *Disable* the port monitoring function. The default is Disable.

Monitoring Port:

This is the **slot.port** that the *monitored* data is sent to. This is the **slot.port** that a Network Analyzer is attached to. The slot can be 0, 1 or 2. The default is 0. The port range is 1 to 16 for Slot 0; 1-8 for Slots 1 and 2.

Port to be Monitored:

This is the port from which data is captured and sent to the monitoring port; the port under analysis. The port range is 1 to 16 for Slot 0; 1-8 for Slots 1 and 2.

Configuring Spanning Tree Protocol (STP)

Spanning Tree Switch Configuration/Status

The 8275-416 participates in Spanning Tree Protocol (STP). STP allows you to configure redundant paths in the switch topology, and have the 8275-416 automatically blocks redundant paths to prevent loops (fault tolerant). If an active path is broke and a backup path is available, the 8275-416 finds the redundant path and enables it (fault tolerant). Without STP, a path failure means loss of connectivity for the affected part of the network, forcing manually established connectivity or redundant loops in the network.

The 8275-416 complies with the IEEE 802.1D standard. Refer to the IEEE 802.1D document for STP specifications. 8275-416 supports one STP for the entire switch.

You can configure the Spanning Tree Protocol for the 8275-416 . Select **Device Configuration Menu** from the Main Menu. Then select **Spanning Tree Switch**

Configuration/Status from the Device Configuration Menu. (See Figure 32 .)

```
TELNET.EXE
IBM 8275-416 High Performance Switch@
- Spanning Tree Switch Configuration/Status Menu -          00:04:AC:6B:0D:80
Unit ID ... <1>
STP Specification . . . . . IEEE 802.1D
STP Base MAC Address . . . . . 00:04:AC:6B:0D:80
STP Topology Change Count . . . . . 0
STP Time Since Topology Changed . . . 0 day 0 hr 0 min 0 sec
STP Designated Root . . . . . 8000 00:04:AC:6B:0D:80
STP Root Port . . . . . 0
STP Root Cost . . . . . 0
STP Max. Age (seconds). . . . . 20
STP Hello Time (seconds). . . . . 2
STP Forward Delay (seconds) . . . . . 15
STP Hold Time (seconds) . . . . . 1
Spanning Tree Algorithm . . . . . <Disable>
STP Bridge Priority . . . . . [32768 ]
STP Bridge Max. Age (seconds) . . . . [20 ]
STP Bridge Hello Time (seconds) . . . [2 ]
STP Bridge Forward Delay (seconds). . [15 ]
Push Space Bar to toggle reset port forward transition count
APPLY      MAIN MENU    PREV MENU (F3)  HELP (F1)

For changes, [overtime] or <use space bar>. Press ESC to discard change. Use TAB
or Arrow keys to navigate. F2=toggle between menu text and Command Bar. F4=SAVE
```

Figure 32. Spanning Tree Switch Configuration/Status

The following section lists and describes the STP configuration functions and related parameters.

Spanning Tree Algorithm:

Indicates if the 8275-416 participates in Spanning Tree Protocol. A status of Enable means that 8275-416 participates in the STP. Disable means that 8275-416 does not participate in the STP. The default is Enable.

Bridge Priority:

Decimal value which indicates the priority of the 8275-416 . This value ranges from 0 to 65535. The default value is 32768. The lower the value, the higher the priority. The 8275-416 with the lowest priority value becomes the *root* (IEEE 802.1D). The default is 32768.

Maximum Age Time:

When the 8275-416 is *root*, Maximum Age Time is the time in seconds after which the configuration message used by the Spanning Tree Algorithm is discarded. The range is between 6 to 40 seconds. The default value is 20 seconds.

Hello Time:

When the 8275-416 is *root*, Hello Time is the time in seconds that the 8275-416 waits before sending the next configuration message. The value is range between 1 and 10 seconds. The default value is 2 seconds.

Forward Delay Time:

This value specifies the time spent in "Listening and Learning" mode before forwarding packets. The range is between 4 to 30 seconds. The default is 15 seconds.

Cost:

This output is automatically calculated. The cost represents the shortest distance from any switch to the root switch interval for the unit announcing

its presence on the network. The range is between 0 to 65,535. The default value is 0. If Status is Enable, the 8275-416 participates in the Spanning Tree Protocol.

Spanning Tree Port Configuration/Status

You can configure the Spanning Tree Protocol by ports. Select **Device Configuration Menu** from the Main Menu. Then select **Spanning Tree Port Configuration/Status Menu** from the Device Configuration Menu. (See Figure 33.)

```

TELNET.EXE
IBM 8275-416 High Performance Switch@
- Spanning Tree Port Configuration/Status Menu -          00:04:AC:6B:0D:80

Unit ID ... <1>          Slot ... <0>          Port ID ... <1>

STP Port ID . . . . . 8001
STP Port Designated Root . . . . . 8000 00:04:AC:6B:0D:80
STP Port Designated Cost . . . . . 0
STP Port Designated Bridge . . . . . 8000 00:04:AC:6B:0D:80
STP Port Designated Port . . . . . 8001
STP Port Forward Transitions Count . . . . . 0
STP Port State . . . . . Forwarding

STP Port Priority . . . . . [128]
STP Port Path Cost . . . . . [0 ]

Push Space Bar to toggle the Slot Number

APPLY    MAIN MENU    PREV MENU (F3)    HELP (F1)

For changes, [overtyp] or <use space bar>. Press ESC to discard change. Use TAB
or Arrow keys to navigate. F2=toggle between menu text and Command Bar. F4=SAVE
  
```

Figure 33. Spanning Tree Port Configuration/Status

The parameter values are:

Port Priority:

Decimal value which indicates the priority of the 8275-416 . This value ranges from 0 to 255. The lower the value, the higher the priority. The 8275-416 with the lowest priority value becomes the *root* (IEEE 802.1D). The default is 128.

Port Path Cost:

This output is automatically calculated. The cost represents the shortest distance from any switch to the root switch interval for the unit announcing its presence on the network. The range is between 0 to 65535. The default value starts at 0, then it is 100 for 10Mbps ports; and it is 19 for 100Mbps ports.

Configuring Broadcast Storm Recovery

Select **Device Configuration** on the Main Menu. Then, from the Device Configuration Menu, select **Broadcast Storm Recovery Menu**. Broadcast storm recovery can be enabled or disabled; the default is Disable. (See Figure 34 on page 49.)



Figure 34. Broadcast Storm Recovery

Configuring 802.3x Flow Control

Select **Device Configuration** on the Main Menu. Then, from the Device Configuration Menu, select **802.3x Flow Control Menu**. 802.3x Flow Control can be enabled or disabled; the default is Disable. (See Figure 35.)

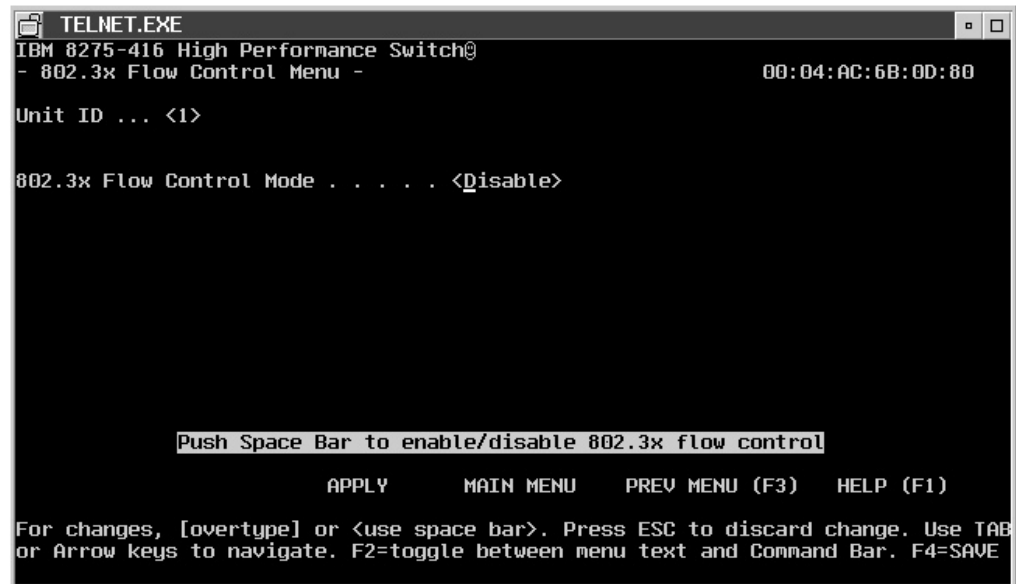

Figure 35. 802.3x Flow Control

Statistics

To access statistics, select **Statistics Menu** on the Main Menu. Traffic statistics are kept by port. Details and summaries of packets broadcast, transmitted, and switched, as well as, error packets and discarded packets are the types of statistics kept for your 8275-416 .

After making your selection, the screens containing statistics will refresh every few seconds. The following panels represent examples of the types of statistics that you can select from the **Statistics Menu**.

Port Summary Statistics

See Figure 36 for a summary of port statistics.

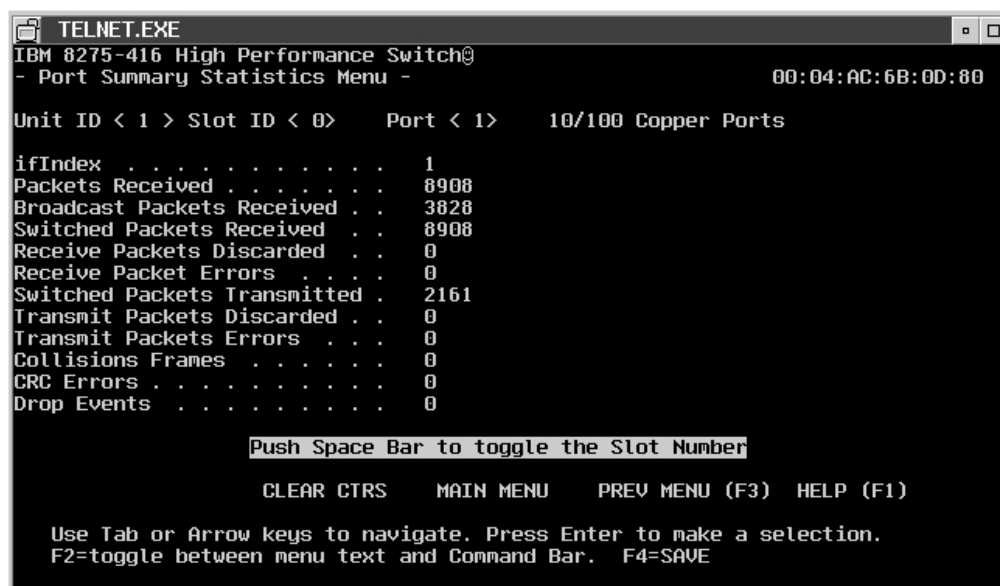

```
TELNET.EXE
IBM 8275-416 High Performance Switch@
- Port Summary Statistics Menu -                                00:04:AC:6B:0D:80

Unit ID < 1 > Slot ID < 0 >      Port < 1 >      10/100 Copper Ports
ifIndex . . . . . 1
Packets Received . . . . . 8908
Broadcast Packets Received . . 3828
Switched Packets Received . . 8908
Receive Packets Discarded . . 0
Receive Packet Errors . . . 0
Switched Packets Transmitted . 2161
Transmit Packets Discarded . . 0
Transmit Packets Errors . . . 0
Collisions Frames . . . . . 0
CRC Errors . . . . . 0
Drop Events . . . . . 0

Push Space Bar to toggle the Slot Number

CLEAR CTRS      MAIN MENU      PREV MENU (F3)  HELP (F1)

Use Tab or Arrow keys to navigate. Press Enter to make a selection.
F2=toggle between menu text and Command Bar.  F4=SAVE
```

Figure 36. Port Summary Statistics

Port Detailed Statistics

See Figure 37 on page 51 for a summary of port statistics.

```

TELNET.EXE
IBM 8275-416 High Performance Switch@
- Port Detailed Statistics Menu -                                00:04:AC:6B:0D:80

Unit ID < 1 > Slot ID < 0 >   Port < 1 >   10/100 Copper Ports
Octets Received . . . . . 1541186   Alignment Errors . . . . . 0
Packets Received . . . . . 8974     Fragments Received . . . . . 0
Unicast Packets Received . . 1459   Jabbers Received . . . . . 0
Non-Unicast Packets Received 7515   Undersize Packets Received 0
Received Pkts Unknow Protocol 0     Oversize Packets Received . 0
Broadcast Packets Received . 3837   CRC Errors . . . . . 0
Multicast Packets Received . 3678   Single Collision Frames . . 0
Packets Received 64 Octets . 5292   Multiple Collision Frames . 0
Packets Received 65-127 . . 212    Excessive Collisions . . . 0
Packets Received 128-255 . . 117    Octets Transmitted . . . . 548422
Packets Received 256-511 . . 3353   Unicast Pkts Transmitted . 1505
Packets Received 512-1023 . . 0     Non-Unicast Pkts Transmit . 705
Packets Received 1024-1518 . 0     Switched Packets Transmit . 2210
Drop Events . . . . . 0           Transmit Queue Length (Pkts)0
Switched Packets Received . . 8974   Maximum Info Field Transmit 1500

Push Space Bar to toggle the Slot Number
CLEAR CTRS   MAIN MENU   PREV MENU (F3)   HELP (F1)

Use Tab or Arrow keys to navigate. Press Enter to make a selection.
F2=toggle between menu text and Command Bar. F4=SAVE

```

Figure 37. Port Detailed Statistics

Management Statistics

See Figure 38 for a summary of port statistics.

```

TELNET.EXE
IBM 8275-416 High Performance Switch@
- Management Statistics Menu -                                00:04:AC:6B:0D:80

Maximum Size of INFO Field . . . . . 1500
Octets Received . . . . . 1278750
Unicast Packets Recieved . . . . . 1516
Non-Unicast Packets Received . . . . . 3711
Receive Packets Discarded . . . . . 0
Receive Packets Errors . . . . . 0
Receive Packets Unknown Protocols . . . . . 0
Octets Transmitted . . . . . 332538
Unicast Packets Transmitted . . . . . 1561
Non-Unicast Packets Transmitted . . . . . 710
Transmit Packets Discarded . . . . . 0
Transmit Packets Errors . . . . . 0
Transmit Queue Len. (Packets) . . . . . 0

Clear statistic counters.

CLEAR CTRS   MAIN MENU   PREV MENU (F3)

Use Tab or Arrow keys to navigate. Press Enter to make a selection.
F2=toggle between menu text and Command Bar. F4=SAVE

```

Figure 38. Management Statistics

User Account Management

On the Main Menu, select **User Account Management Menu**. Figure 39 shows the data entry screen for specifying your user names, passwords, and access mode.

```
TELNET.EXE
IBM 8275-416 High Performance Switch@
- User Account Management Menu -                                00:04:AC:6B:0D:80

Unit ID ... <1>

  User Name      Password      Confirm
  -----      -
  [admin  ]      [          ]      [          ]      Read/Write      Enabled
  [guest  ]      [          ]      [          ]      Read Only       <Enable >
  [      ]      [          ]      [          ]      Read Only       <Disable>
  [      ]      [          ]      [          ]      Read Only       <Disable>
  [      ]      [          ]      [          ]      Read Only       <Disable>
  [      ]      [          ]      [          ]      Read Only       <Disable>

Enter the users name (Max 8 characters)

      APPLY      MAIN MENU      PREV MENU (F3)      HELP (F1)

For changes, [overtime] or <use space bar>. Press ESC to discard change. Use TAB
or Arrow keys to navigate. F2=toggle between menu text and Command Bar. F4=SAVE
```

Figure 39. User Account Management Menu

The 8275-416 allows you to add and delete users and set user passwords for the 8275-416 . You are to provide the following information:

User Name:

User name can be up to eight alphanumeric characters. The User Name is not case sensitive. Up to six user names (accounts) can be defined; one with read/write access mode and five with read only access mode.

Password:

The password can be up to eight alphanumeric characters and is not case sensitive. A blank password indicates no password. The default value is blank.

Confirm Password:

The confirm password can be up to eight alphanumeric characters. The confirm password is not case sensitive. A blank confirm password indicates no password. The default value is blank.

Access Mode:

This value is not configurable. User access mode can be:

read/write

Only one user can be defined with read/write access mode per 8275-416 . This user can change the status of other users, add and delete users, change passwords and change configurations, and use system utilities.

read only

Up to five users can be defined with read only access mode per 8275-416 . The message of read only appears on configuration screens when a read only user is logged in.

Status:

Status can be Enable, Disable or Delete. Enable means that the user name is authorized to access the 8275-416 . Disable means that the user name is not allowed to access the 8275-416 . Delete means the user will be removed from the list upon an apply or save.

System Utilities

The system utilities can be used only by users with read/write access. You can use the system utilities by selecting **System Utilities Menu** on the Main Menu. Figure 40 shows the available utilities.

Saving Applied Changes

There are two ways to save applied changes which result in the changes being retained across a reset:

- Pressing the F4 key.
- Selecting **Save Applied Changes** on the System Utilities Menu.

You can permanently save configuration changes by pressing the F4 key or going to the System Utilities Menu and selecting **Save Applied Changes**, as shown in Figure 40.

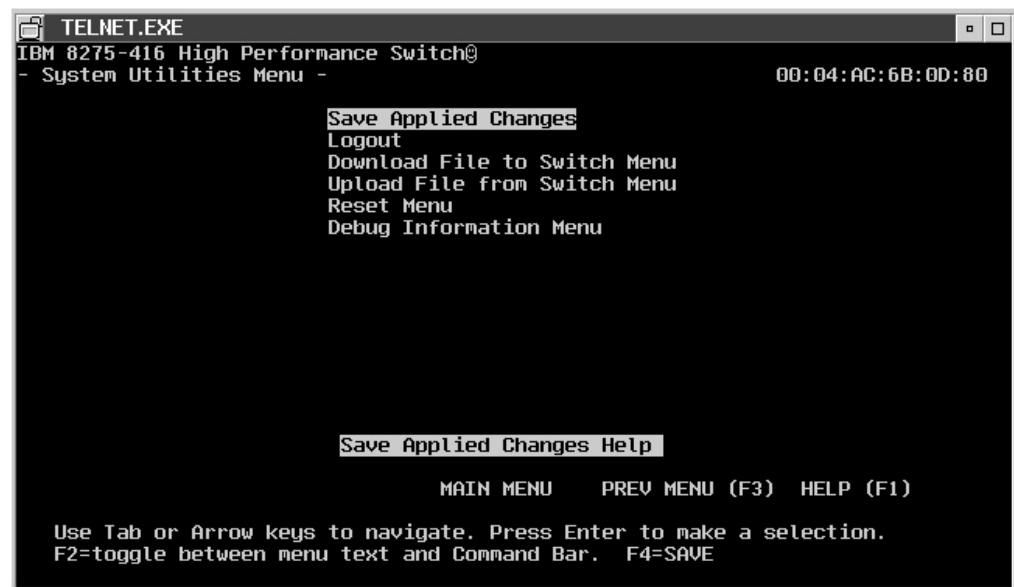

Figure 40. Save Applied Changes Menu

Logging Out

When you have finished using the terminal interface, ensure you have saved and applied all configuration changes before you Logout. The terminal interface provides an orderly way to logout. One way is to use the Logout command on the Main Menu. Another way to Logout is to select **System Utilities Menu** from the Main menu, then select **Logout** as shown in Figure 41 on page 54.

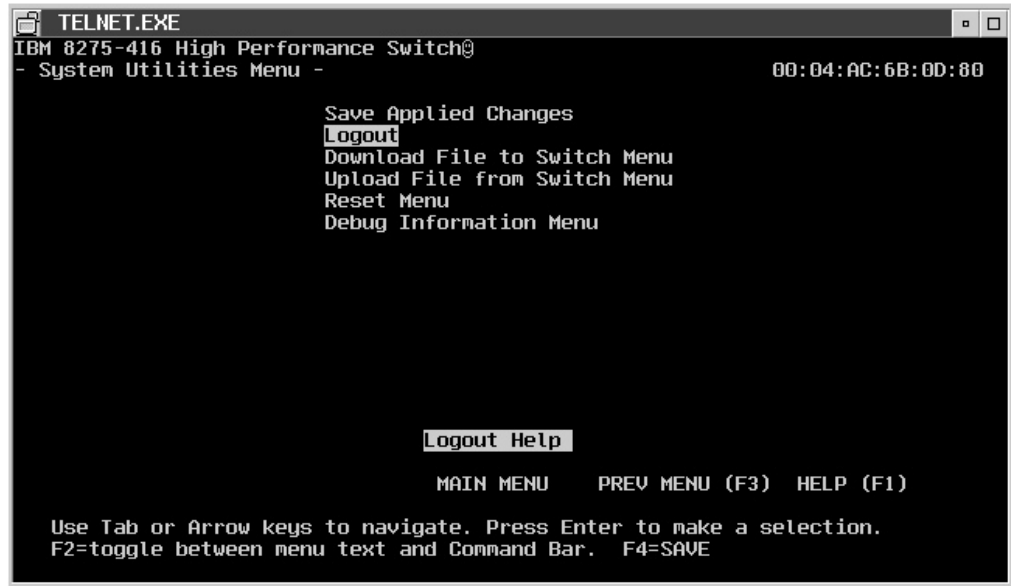

Figure 41. Logout Utility

Handling Files

To upload or download a file, select **System Utilities Menu** from the Main Menu. Then make the appropriate selection from the System Utilities Menu.

The 8275-416 can download or upload files. Downloading is the transfer of files from a remote server into the 8275-416 . Uploading is the transfer of files from the 8275-416 to a remote server.

Configuration settings can be retrieved from the 8275-416 as a binary file. A binary configuration file can be sent to the 8275-416 . This allows you to back up the configuration or to easily update the configuration of multiple 8275-416 s. Additionally, a configuration file may be provided to IBM support personnel for problem determination.

The last-saved configuration used by the 8275-416 is retained after a code update or a reset.

Downloading a File to the 8275-416

Downloading is the transfer of files from a remote server into the 8275-416 . (See Figure 42 on page 55.)

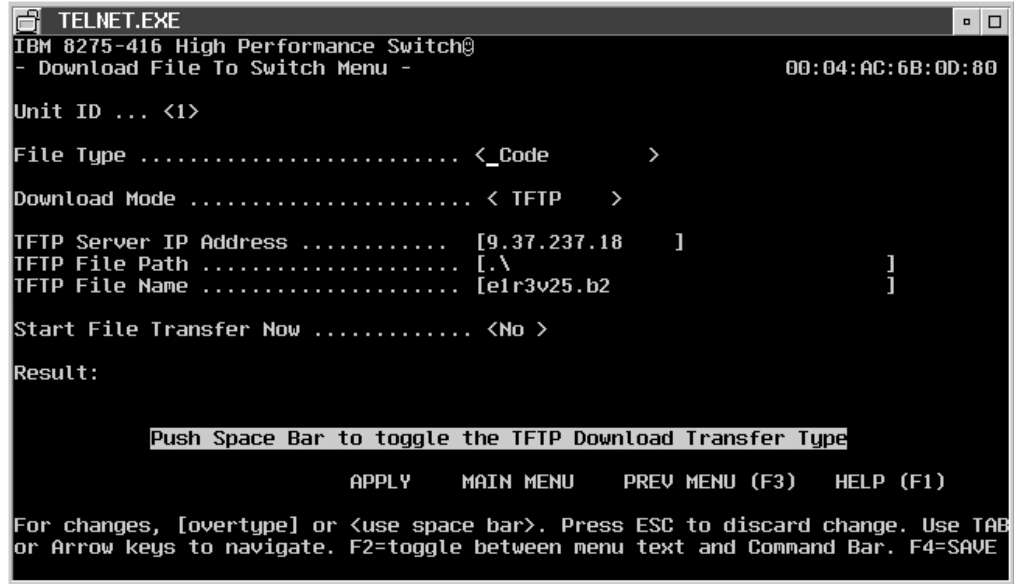

Figure 42. Downloading File to the 8275-416 .

Uploading a File from the 8275-416

Uploading is the transfer of files from the 8275-416 to a remote server. (See Figure 43.)

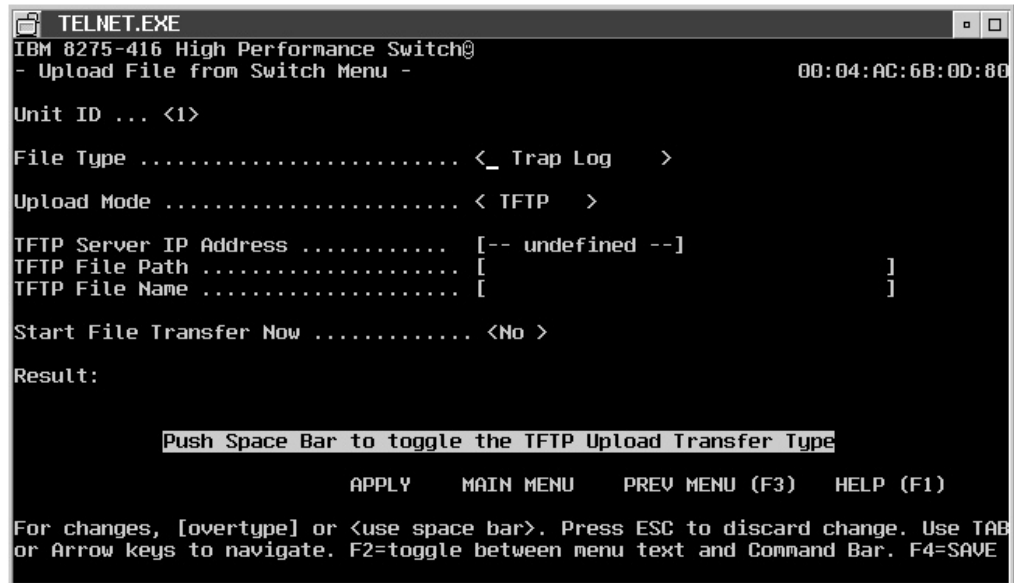

Figure 43. Uploading File from the 8275-416 .

The following parameters apply to uploading and downloading of files.

File Type:

The file types are:

For Download

- Code (the default)
- Configuration

For Upload

- Configuration
- Error log
- System trace
- Trap log (the default)

Upload or Download Mode

The mode is either XMODEM or TFTP. XMODEM is only valid when file transfer is initiated via the serial EIA 232 port. The default value is XMODEM.

Start Transfer Now:

You indicate Yes or No.

File Name:

The file name can be up to 16 alphanumeric characters. The 8275-416 remembers the last file name used. The default value is blank.

Note: File Name, File Path, and TFTP Server IP Address are applicable only if the Transfer Mode is TFTP.

File Path:

The directory path where the file is located. The 8275-416 remembers the last file path used. The default value is blank.

TFTP Server IP Address:

The IP address of the server where the file is located. It is valid only when the Transfer Mode is TFTP. The address is 4 decimal bytes ranging from 0 to 255. The default value is zeroes.

Reset Utility

8275-416 allows you to reset the 8275-416 without powering off. Reset means that all network connections are terminated and the boot code executes. The 8275-416 uses the stored configuration to initialize the 8275-416 . You are prompted for confirmation if you want the reset to proceed. A successful reset is evidenced by the LEDs on the 8275-416 .

After selecting Reset Menu from the System Utilities Menu, you are given the choice of the resets you can request as shown Figure 44 on page 57.

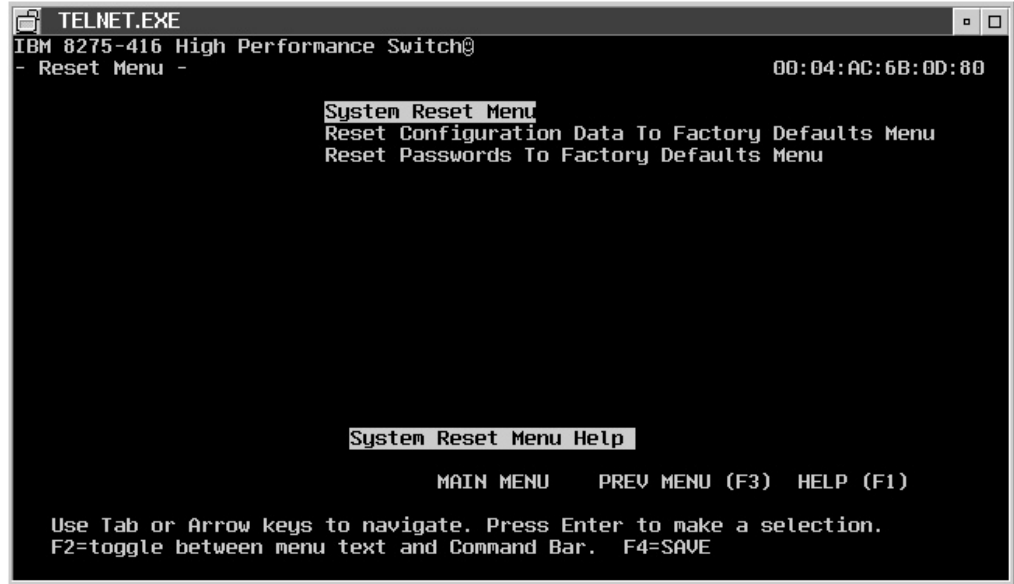

Figure 44. Reset Menu

Resetting System

Reset the system by indicating the particular unit as shown in Figure 45. You must identify the 8275-416 to reset. None is the default.

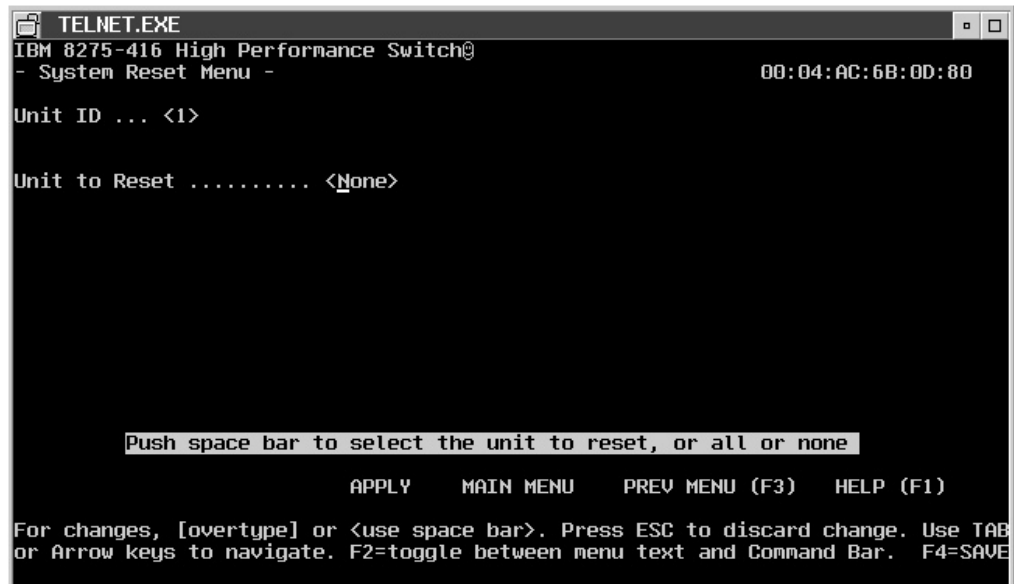

Figure 45. Reset Menu

Resetting Configuration Data to Factory Default Values

8275-416 allows you to reset the configuration to factory default values without powering off. The factory defaults are not restored until the 8275-416 is reset. The

8275-416 is automatically reset when this command is processed. You are prompted for confirmation if you want the reset to proceed.

Reset the configuration data to the factory defaults by indicating the particular unit as shown in Figure 46. You must identify the 8275-416 to reset. None is the default.

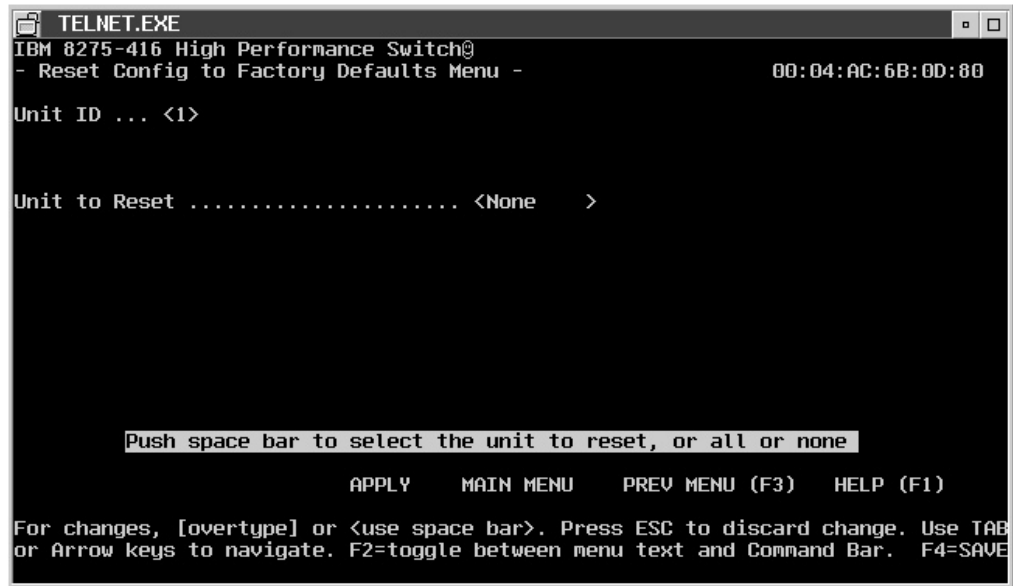

Figure 46. Reset Configuration Data to Factory Defaults

Resetting Passwords to Factory Default Values

8275-416 allows you to reset user passwords to factory default values without powering off. The factory defaults are not restored until the 8275-416 is reset. The 8275-416 is automatically reset when this command is processed. You are prompted for confirmation if you want the reset to proceed.

Reset the passwords by indicating the particular unit as shown in Figure 47 on page 59. You must identify the 8275-416 to reset. None is the default.



Figure 47. Reset Passwords to Factory Defaults

Debug Utility

Select the **Debug Menu** from the System Utilities Menu panel.

Note: Using the Debug function may alter the state of the 8275-416 and cause unexpected results. The intended for use of this Debug function is for trained personnel only.

You are prompted to indicate if want to continue (Y=yes or N=no). If you press "Y", the debug command line interface is used.

Debug utility is only valid via the EIA-232 interface; it does not work via Web or telnet.

Chapter 5. Using the Web Interface

You can manage your 8275-416 through your Web browser and Internet connection. This type of management is referred to as Web-based management. The following are the basic requirements for Web browsers to access the 8275-416 :

- Support for HTML version 4.0, or later
- Support for HTTP version 1.1, or later
- Support for JavaScript version 1.2, or later

This chapter explains how to access the 8275-416 Web-based management panels to configure and manage your 8275-416 .

It is important to note that there are equivalent functions offered in the Web interface as in the terminal interface (that is, there are usually the same menus to accomplish a task). For example, you log in, there is a Main Menu with the same functions available, and so on. The only difference is that the panels are web-like in design. So, if you have read “Chapter 3. Configuring your 8275-416” on page 17 and “Chapter 4. Using the Terminal Interface” on page 25, navigating the Web interface will not be difficult. This chapter is a brief introduction to the Web interface.

Web Page Layout

A Web interface panel for the 8275-416 Web page consists of three frames. Frame 1, across the top, appears a banner graphic of the 8275-416 . Frame 2, at the bottom-left displays a hierarchical-tree view. The tree consists of a combination of folders, sub-folders, and configuration and status HTML pages. You can think of the folders and sub-folders as branches and the configuration and status HTML pages as leafs. Only the selection of a leaf (not a folder or sub-folder) will cause Frame 2 to display a new HTML page. A folder or sub-folder has no corresponding Frame 3 HTML page. Frame 3, the bottom-right frame, displays the currently selected device configuration status or the user configurable information that you have selected from the Tree View of Frame 2, or both. You can resize each of these frames. There are no fixed-sized frames.

Starting the Web Interface

Note: You must configure the IP address of the 8275-416 before using the Web interface.

Follow these steps to bring up the 8275-416 Web interface:

1. Enter the **IP address** of the 8275-416 in the address field of your Web browser and press Enter.
2. Log in with your user name and password. Press **Enter**
3. The navigation tree is displayed in Frame 2, and the System Description Menu is displayed in Frame 3. Make your selection by clicking on the appropriate item in the navigation tree in Frame 2.
- 4.

Commands

The following commands are used throughout the Web interface panels or the 8275-416 :

Undo Restores any changes made on the panel to their original value since the last Apply or Save.

Save Implements and saves the changes you just made. Some settings may require you to reset the system in order for them to take effect.

Apply Implements the changes you just made. Some settings may require you to reset the system for them to take effect.

Refresh

The Refresh button that appears next to the Apply button in Web interface panels refreshes the data on the panel.

Restart

Refreshes the list and displays the data starting at the beginning of the list.

Next Displays the next set of information in the list.

Chapter 6. Troubleshooting and Obtaining Service

Diagnosing Problems

This chapter contains procedures that help you to troubleshoot problems with your 8275-416 and its connections to other devices.

Be sure you read “Appendix A. Safety Information” on page 67 before proceeding.

Obtaining Software

To obtain support information, including technical tips, current product information, and code updates and fixes the 8275-416 , visit the IBM Networking Tech Support page at:

<http://www.networking.ibm.com/support>

You may also subscribe to receive e-mail notifications about code updates, tips, and FAQs for your 8275-416 .

Troubleshooting in a Network

The 8275-416 terminal interface, Web interface, and SNMP management agent give you access to important statistics and other information about the network. To obtain these statistics, see “Chapter 4. Using the Terminal Interface” on page 25 and “Chapter 5. Using the Web Interface” on page 61 and select the appropriate screens.

Start of Troubleshooting Process

If one or more devices (such as workstations) connected to an 8275-416 are unable to communicate with other devices in the network, use the following steps to start the troubleshooting process:

1. Locate the 8275-416 to which the device is connected. Use the network sketch, the label on the cable connected to the device, or other network records to help you locate the 8275-416 .
2. Have available any documentation associated with the feature modules that are installed on the 8275-416 .
3. If you have an EIA 232 console session set up, (see “Chapter 2. Accessing the 8275-416” on page 11), you can use it to determine if diagnostics have been completed correctly.
4. Observe the LEDs on the 8275-416 front panel. The location of these LEDs is shown in Figure 2 on page 6 with explanations of the LED status conditions in the accompanying table. Ignore the feature module LEDs at this time. Review this information before proceeding with the troubleshooting process.
5. If the LED status are not OK, locate in Table 4 on page 64, the symptom that best describes the communication problem and the LED status you observed. Then go the section that contains the recommended actions for resolving the problem and follow that procedure.

Choosing a Troubleshooting Procedure

Use Table 4 to determine which troubleshooting procedure you should use. Unless otherwise stated, references to the OK and Fault LEDs are those on the 8275-416 .

Table 4. Troubleshooting— Isolating Problems

Symptom and LED State	Action
The Fault LED, the OK LED are off, and the fan is not running.	Go to “Procedure A”
The Fault LED is On. If the Fault LED is blinking, diagnostics are in process.	Go to “Procedure B”
None of the devices connected to the 8275-416 can communicate , the Fault LED is Off and the Power (I) LED is On.	Go to “Procedure C” on page 65
A single device connected to the 8275-416 is having trouble communicating.	Go to “Procedure D” on page 65
A feature module Fault LED is On.	Remove and replace the feature module.

Note: The term “segment” refers to a single cable or interconnected cables between a port and the device at the other end.

Procedure A

Use this procedure if all LEDs are Off:

1. Verify that the ac power outlet to which the 8275-416 power supply is connected is active. If an uninterruptible power supply (UPS) is being used to provide ac power, ensure that the UPS is working correctly.
2. Verify that the power cord is installed correctly.
3. If the preceding conditions are satisfied, the power supply is defective. See “Obtaining Service” on page 65.

Procedure B

Use this procedure if the Fault LED is On

1. Reset the 8275-416 by disconnecting the power cord from the outlet, waiting 10 seconds, and reconnecting the power cord to the outlet. If this corrects the problem, resume using the 8275-416 .
2. One or more bad feature modules can cause this symptom, and the remaining ports might continue to operate.
 - a. If you have feature modules, remove them.
 - b. Reset the 8275-416 .
 - c. If the 8275-416 comes up, reinstall the feature modules one at a time, and reset the 8275-416 to determine the failing feature module.
3. If the problem is not corrected, the 8275-416 is defective. See “Obtaining Service” on page 65.

Procedure C

Use this procedure if all devices connected to the 8275-416 are having communication problems, the Fault LED is Off and the OK LED is On:

1. Reset the 8275-416 by disconnecting the power cord from the outlet, waiting 10 seconds, and reconnecting the power cord to the ac outlet.
 - If the problem goes away, resume using the 8275-416 .
 - If the status LEDs indicate a failure, go to “Procedure B” on page 64.
 - If the problem persists, check all the configuration parameters.
 - If the problem has still not been resolved, go to “Procedure D” and try to get individual ports working.

Procedure D

Use this procedure if one device connected to the 8275-416 is having a communication problem, the Fault LED is Off, the OK LED is On and other attached devices can communicate through the 8275-416 :

1. If the port LED is Off (left LED on 10/100BASE-TX port and single port LED on 100BASE-FX port), check the cable and the attached device. Check the configuration settings to ensure they are OK.
2. If the port Link LED is On:
 - a. Check the port configuration and make sure the port admin mode is Enabled.
 - b. If the above check is OK, try pinging the attached device from the 8275-416 . Make sure the 8275-416 is configured for in-band connectivity.
 - c. If ping is successfully received, go to Step 5.
 - d. If the ping is not received, go to Step 3.
3. Restart the communications program on the failed connected device.
 - If the communications program appears to start without errors, observe the port LED on the 8275-416 port. If it is On it might have gone away. Check the port configuration parameters for possible causes of the failure.
 - If the problem persists, go to Step 4.
4. For each device that is having a communication problem, connect its segment to another identically configured Ethernet port on the 8275-416 . Try each of the remaining ports to determine if the problem will go away.
 - If the problem goes away, the problem might be in the 8275-416 . See “Obtaining Service”.
 - If the problem persists, continue with Step 5.
5. The problem does not appear to be in the 8275-416 and the cables and devices connected to the 8275-416 . The problem might be in the network applications or other software running on the devices that are having the communication problem. Refer to the networking software documentation for software problem determination procedures, or consult your network administrator for assistance.

Obtaining Service

There are no user-serviceable parts inside the 8275-416 chassis. The 8-Port 10/100BASE-TX and 8-Port 100BASE-FX feature modules are individually replaceable by the user.

If you need assistance in troubleshooting or you need service for your 8275–416, call IBM at:

- 1 800 772-2227 in the United States
- 1 800 426-7378 (1 800 IBM-SERV) in Canada.
- In other locations, contact your place of purchase.

Refer to your IBM Warranty for information concerning service for the product, or contact the place where you purchased the product.

Appendix A. Safety Information



Danger: Before you begin to install this product, read the safety information in *Caution: Safety Information—Read This First*, SD21-0030. This booklet describes safe procedures for cabling and plugging in electrical equipment.



Gevaar: Voordat u begint met de installatie van dit produkt, moet u eerst de veiligheidsinstructies lezen in de brochure *PAS OP! Veiligheidsinstructies—Lees dit eerst*, SD21-0030. Hierin wordt beschreven hoe u elektrische apparatuur op een veilige manier moet bekabelen en aansluiten.



Danger: Avant de procéder à l'installation de ce produit, lisez d'abord les consignes de sécurité dans la brochure *ATTENTION: Consignes de sécurité—A lire au préalable*, SD21-0030. Cette brochure décrit les procédures pour câbler et connecter les appareils électriques en toute sécurité.



Perigo: Antes de começar a instalar este produto, leia as informações de segurança contidas em *Cuidado: Informações Sobre Segurança—Leia Isto Primeiro*, SD21-0030. Esse folheto descreve procedimentos de segurança para a instalação de cabos e conexões em equipamentos elétricos.



危險：安裝本產品之前，請先閱讀
"Caution: Safety Information—Read
This First" SD21-0030 手冊中所提
供的安全注意事項。這本手冊將會說明
使用電器設備的纜線及電源的安全程序。



Opasnost: Prije nego što počnete sa instalacijom produkta, pročitajte naputak o pravilima o sigurnom rukovanju u Upozorenje: Pravila o sigurnom rukovanju - Prvo pročitaj ovo, SD21-0030. Ovaj privitak opisuje sigurnosne postupke za priključivanje kabela i priključivanje na električno napajanje.



Upozornění: než zahájíte instalaci tohoto produktu, přečtěte si nejprve bezpečnostní informace v pokynech „Bezpečnostní informace“ č. 21-0030. Tato brožurka popisuje bezpečnostní opatření pro kabeláž a zapojení elektrického zařízení.



Fare! Før du installerer dette produkt, skal du læse sikkerhedsforskrifterne i *NB: Sikkerhedsforskrifter—Læs dette først* SD21-0030. Vejledningen beskriver den fremgangsmåde, du skal bruge ved tilslutning af kabler og udstyr.



Gevaar Voordat u begint met het installeren van dit produkt, dient u eerst de veiligheidsrichtlijnen te lezen die zijn vermeld in de publikatie *Caution: Safety Information - Read This First*, SD21-0030. In dit boekje vindt u veilige procedures voor het aansluiten van elektrische apparatuur.



VAARA: Ennen kuin aloitat tämän tuotteen asennuksen, lue julkaisussa *Varoitus: Turvaohjeet—Lue tämä ensin*, SD21-0030, olevat turvaohjeet. Tässä kirjasessa on ohjeet siitä, miten sähkölaitteet kaapeloidaan ja kytketään turvallisesti.



Danger : Avant d'installer le présent produit, consultez le livret *Attention : Informations pour la sécurité — Lisez-moi d'abord*, SD21-0030, qui décrit les procédures à respecter pour effectuer les opérations de câblage et brancher les équipements électriques en toute sécurité.



Vorsicht: Bevor mit der Installation des Produktes begonnen wird, die Sicherheitshinweise in *Achtung: Sicherheitsinformationen—Bitte zuerst lesen*, IBM Form SD21-0030. Diese Veröffentlichung beschreibt die Sicherheitsvorkehrungen für das Verkabeln und Anschließen elektrischer Geräte.



Κίνδυνος: Πριν ξεκινήσετε την εγκατάσταση αυτού του προϊόντος, διαβάστε τις πληροφορίες ασφάλειας στο φυλλάδιο *Caution: Safety Information—Read this first*, SD21-0030. Στο φυλλάδιο αυτό περιγράφονται οι ασφαλείς διαδικασίες για την καλωδίωση των ηλεκτρικών συσκευών και τη σύνδεσή τους στην πρίζα.



Vigyázat: Mielőtt megkezdi a berendezés üzembe helyezését, olvassa el a *Caution: Safety Information— Read This First*, SD21-0030 könyvecskében leírt biztonsági információkat. Ez a könyv leírja, milyen biztonsági intézkedéseket kell megtenni az elektromos berendezés huzalozásakor illetve csatlakoztatásakor.



Pericolo: prima di iniziare l'installazione di questo prodotto, leggere le informazioni relative alla sicurezza riportate nell'opuscolo *Attenzione: Informazioni di sicurezza — Prime informazioni da leggere* in cui sono descritte le procedure per il cablaggio ed il collegamento di apparecchiature elettriche.



危険： 導入作業を開始する前に、安全に関する小冊子SD21-0030 の「最初にお読みください」(Read This First)の項をお読みください。この小冊子は、電気機器の安全な配線と接続の手順について説明しています。



위험: 이 제품을 설치하기 전에 반드시
"주의: 안전 정보-시작하기 전에"
(SD21-0030) 에 있는 안전 정보를
읽으십시오.



ОПАСНОСТ

Пред да почнете да го инсталирате овој продукт, прочитајте ја информацијата за безбедност:
"Предупредување: Информација за безбедност: Прочитајте го прво ова", SD21-0030.
Оваа брошура опишува безбедносни процедури за каблирање и вклучување на електрична опрема.



Fare: Før du begynner å installere dette produktet, må du lese sikkerhetsinformasjonen i *Advarsel: Sikkerhetsinformasjon — Les dette først*, SD21-0030 som beskriver sikkerhetsrutinene for kabling og tilkobling av elektrisk utstyr.



Uwaga:
Przed rozpoczęciem instalacji produktu należy zapoznać się z instrukcją:
"Caution: Safety Information - Read This First", SD21-0030.
Zawiera ona warunki bezpieczeństwa przy podłączeniu do sieci elektrycznej i eksploatacji.



Perigo: Antes de iniciar a instalação deste produto, leia as informações de segurança *Cuidado: Informações de Segurança — Leia Primeiro*, SD21-0030. Este documento descreve como efectuar, de um modo seguro, as ligações eléctricas dos equipamentos.



ОСТОРОЖНО: Прежде чем установить этот продукт, прочтите Инструкцию по технике безопасности в документе "Внимание: Инструкция по технике безопасности -- Прочтите в первую очередь", SD21-0030. В этой брошюре описаны безопасные способы каблирования и подключения электрического оборудования.



Nebezpečnosť: Pred inštaláciou výrobku si prečítajte bezpečnostné predpisy v Výstraha: Bezpečnostné predpisy - Prečítaj ako prvé, SD21-0030. V tejto brožúrke sú opísané bezpečnostné postupy pre pripojenie elektrických zariadení.



Pozor: Preden začnete z inštalácijskeho produktu preberite poglavje: "Opozorilo: Informacije o varnem rokovanju-preberi pred uporabo," SD21-0030. To poglavje opisuje pravilne postopke za kabliranje,



Peligro: Antes de empezar a instalar este producto, lea la información de seguridad en *Atención: Información de Seguridad — Lea Esto Primero*, SD21-0030. Este documento describe los procedimientos de seguridad para cablear y enchufar equipos eléctricos.



Varning — livsfara: Innan du börjar installera den här produkten bör du läsa säkerhetsinformationen i dokumentet *Varning: Säkerhetsföreskrifter— Läs detta först*, SD21-0030. Där beskrivs hur du på ett säkert sätt ansluter elektrisk utrustning.



危險：

開始安裝此產品之前，請先閱讀安全資訊。

注意：

請先閱讀 - 安全資訊 SD21-0030

此冊子說明插接電器設備之電纜線的安全程序。

Appendix B. Notices

References in this publication to IBM products, programs, or services do not imply that IBM intends to make these available in all countries in which IBM operates. Any reference to an IBM product, program, or service is not intended to state or imply that only IBM's product, program, or service may be used. Any functionally equivalent product, program, or service that does not infringe any of IBM's intellectual property rights may be used instead of the IBM product, program, or service. Evaluation and verification of operation in conjunction with other products, except those expressly designated by IBM, are the user's responsibility.

IBM may have patents or pending patent applications covering subject matter in this document. The furnishing of this document does not give you any license to these patents. You can send license inquiries, in writing, to:

IBM Director of Licensing
IBM Corporation
North Castle Drive
Armonk, NY 10504-1785
USA

Notice to Users of Online Versions of This Book

For online versions of this book, you are authorized to:

- Copy, modify, and print the documentation contained on the media, for use within your enterprise, provided you reproduce the copyright notice, all warning statements, and other required statements on each copy or partial copy.
- Transfer the original unaltered copy of the documentation when you transfer the related IBM product (which may be either machines you own, or programs, if the program's license terms permit a transfer). You must, at the same time, destroy all other copies of the documentation.

You are responsible for payment of any taxes, including personal property taxes, resulting from this authorization.

THERE ARE NO WARRANTIES, EXPRESS OR IMPLIED, INCLUDING THE WARRANTIES OF MERCHANTABILITY AND FITNESS FOR A PARTICULAR PURPOSE.

Some jurisdictions do not allow the exclusion of implied warranties, so the above exclusion may not apply to you.

Your failure to comply with the terms above terminates this authorization. Upon termination, you must destroy your machine-readable documentation.

Electronic Emission Notices

Federal Communications Commission (FCC) Statement

This equipment has been tested and found to comply with the limits for a Class A digital device, pursuant to Part 15 of the FCC Rules. These limits are designed to provide reasonable protection against harmful interference when the equipment is operated in a commercial environment. This equipment generates, uses, and can radiate radio frequency energy and, if not installed and used in accordance with the

instruction manual, may cause harmful interference to radio communications. Operation of this equipment in a residential area is likely to cause harmful interference, in which case the user will be required to correct the interference at his own expense.

Properly shielded and grounded cables and connectors must be used in order to meet FCC emission limits. IBM is not responsible for any radio or television interference caused by using other than recommended cables and connectors or by unauthorized changes or modifications to this equipment. Unauthorized changes or modifications could void the user's authority to operate the equipment.

This device complies with Part 15 of the FCC Rules. Operation is subject to the following two conditions: (1) this device may not cause harmful interference, and (2) this device must accept any interference received, including interference that may cause undesired operation.

Industry Canada Class A Emission Compliance Statement

This Class A digital apparatus complies with Canadian ICES-003.

Avis de conformité aux normes d'Industrie Canada

Cet appareil numérique de la classe A est conforme à la norme NMB-003 du Canada.

European Norm (EN) Statement

This product is in conformity with the protection requirements of EU Council Directive 89/336/EEC on the approximation of the laws of the Member States relating to electromagnetic compatibility. IBM cannot accept responsibility for any failure to satisfy the protection requirements resulting from a non-recommended modification of the product, including the fitting of non-IBM option cards.

This product has been tested and found to comply with the limits for Class A Information Technology Equipment according to CISPR 22/European Standard EN 55022. The limits for Class A equipment were derived from commercial and industrial environments to provide reasonable protection against interference with licensed communication equipment.

Warning: This is a Class A product. In a domestic environment this product may cause radio interference in which case the user may be required to take adequate measures.

Zulassungsbescheinigung laut dem Deutschen Gesetz über die elektromagnetische Verträglichkeit von Geräten (EMVG) vom 30. August 1995 (bzw. der EMC EG Richtlinie 89/336)

Dieses Gerät ist berechtigt in Übereinstimmung mit dem Deutschen EMVG das EG-Konformitätszeichen - CE - zu führen.

Verantwortlich für die Konformitätserklärung nach Paragraph 5 des EMVG ist die IBM Deutschland Informationssysteme GmbH, 70548 Stuttgart.

Informationen in Hinsicht EMVG Paragraph 3 Abs. (2) 2:

Das Gerät erfüllt die Schutzanforderungen nach EN 50082-1 und EN 55022 Klasse A.
--

EN 55022 Klasse A Geräte müssen mit folgendem Warnhinweis versehen werden: "Warnung: dies ist eine Einrichtung der Klasse A. Diese Einrichtung kann im Wohnbereich Funkstörungen verursachen; in diesem Fall kann vom Betreiber verlangt werden, angemessene Maßnahmen durchzuführen und dafür aufzukommen."

EN 50082-1 Hinweis: "Wird dieses Gerät in einer industriellen Umgebung betrieben (wie in EN 50082-2 festgelegt), dann kann es dabei eventuell gestört werden. In solch einem Fall ist der Abstand bzw. die Abschirmung zu der industriellen Störquelle zu vergrößern."

Anmerkung: Um die Einhaltung des EMVG sicherzustellen sind die Geräte, wie in den IBM Handbüchern angegeben, zu installieren und zu betreiben.

Japanese Voluntary Control Council for Interference (VCCI) Statement

This product is a Class A Information Technology Equipment and conforms to the standards set by the Voluntary Control Council for Interference by Information Technology Equipment (VCCI). In a domestic environment this product may cause radio interference, in which case the user may be required to take adequate measures.

この装置は、情報処理装置等電波障害自主規制協議会（VCCI）の基準に基づくクラスA情報技術装置です。この装置を家庭環境で使用すると電波妨害を引き起こすことがあります。この場合には使用者が適切な対策を講ずるよう要求されることがあります。

Korean Communications Statement

Please note that this device has been certified for business purpose with regard to electromagnetic interference. If you find this is not suitable for your use, you may exchange it for one of residential use.

Taiwanese Class A Warning Statement

警告使用者：
這是甲類的資訊產品，在居住的環境中使用時，可能會造成射頻干擾，在這種情況下，使用者會被要求採取某些適當的對策。

Class 1 Laser Statement

Class 1 Laser Product

Laser Klasse 1

Laser Klass 1

Luokan 1 Laserlaite

Appareil À Laser de Classe 1

To IEC 825-1:1993

Class 1 LED Statement

Class 1 LED Product

LED Klasse 1

LED Klass 1

Luokan 1 Ledlaite

Appareil À LED de Classe 1

To IEC 825-1:1993

Trademarks

IBM is a trademark of the International Business Corporation in the United States and/or other countries.

Other company, product, and service names may be trademarks or service marks of other companies.

Appendix C. Cable Pinout Diagrams

This appendix specifies Ethernet and null-modem cable pinouts.

Straight-Through 10BASE-T/100BASE-TX Cables

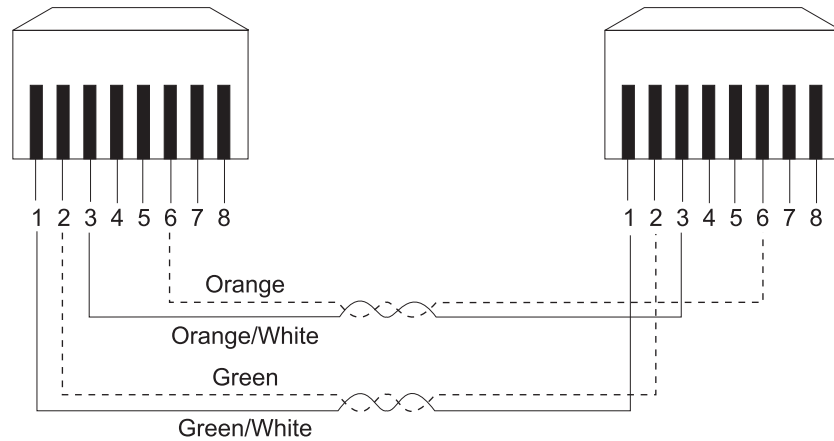

Figure 48. Straight-Through UTP Cable (RJ-45 to RJ-45), T568A

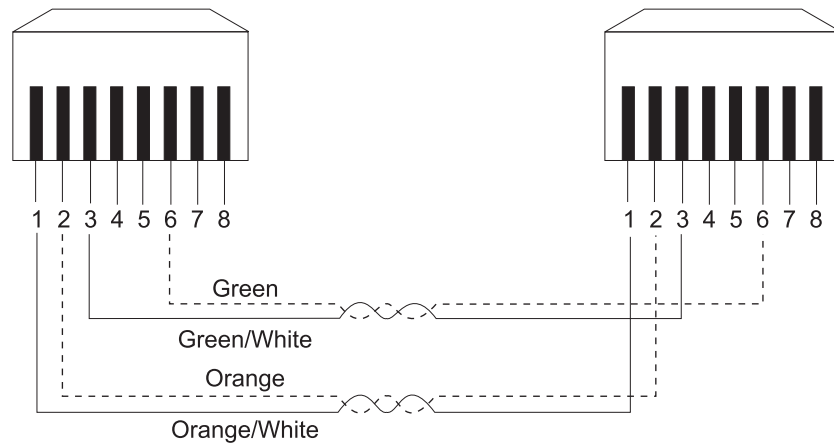

Figure 49. Straight-Through UTP Cable (RJ-45 to RJ-45), T568B

Straight-Through 10BASE-T/100BASE-TX Cables for STP

RJ-45 Pins	IBM Cabling System Data Connector Color Code
1	Red
2	Black
3	Green
6	Orange

Figure 50. Straight-Through STP Cable (RJ-45 to IBM Data Connector)

Crossover 10BASE-T/100BASE-TX Cables

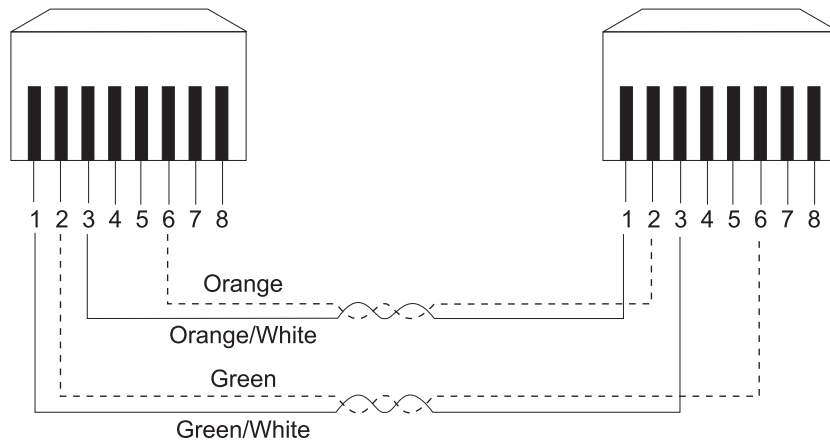

Figure 51. Crossover UTP Cable (RJ-45 to RJ-45), T568A

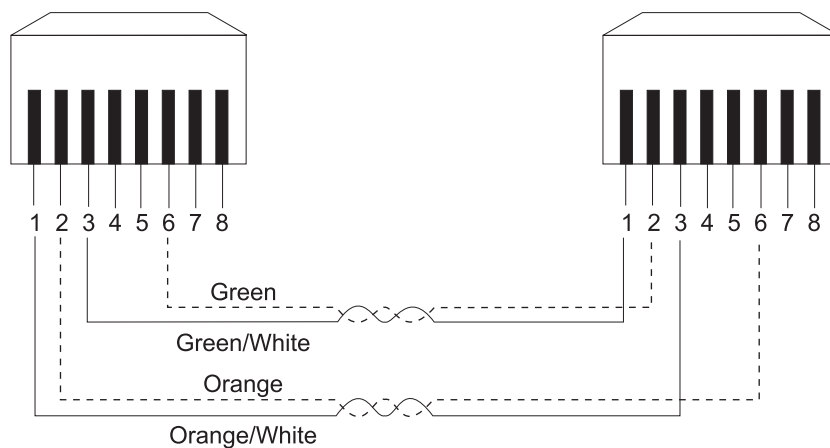

Figure 52. Crossover UTP Cable (RJ-45 to RJ-45), T568B

Crossover 10BASE-T/100BASE-TX Cables for STP

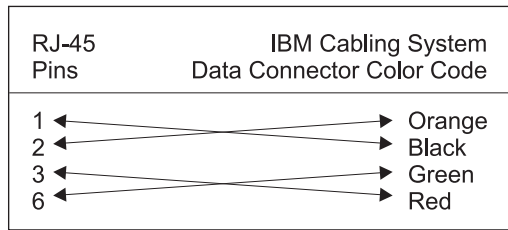

Figure 53. Crossover STP Cable (RJ-45 to IBM Data Connector Crossover)

EIA-232 Port

Pin	Signal Name
Shell	CHS GND
3	TXD
2	RXD
7	RTS
8	CTS
6	DSR
5	SGND
1	DCD
4	DTR
9	RI

Figure 54. Pinout of the EIA-232 Port

Null-Modem Cables

Signal Name	Modem End 25-Pin Male	Switch End 9-Pin Female
TXD	2 ←	3 →
RXD	3 →	2 ←
RTS	4 ←	7 →
CTS	5 →	8 →
DSR	6 →	6 →
GND	7 →	5 →
DCD	8 →	1 →
DTR	20 ←	4 →
RI	22 →	9 →

Figure 55. EIA-232 Modem Cable for Terminal with 25-Pin Connector

Signal Name	Terminal/PC End 9-Pin Male	Switch End 9-Pin Female
TXD	3 →	3 →
RXD	2 ←	2 ←
RTS	7 →	7 →
CTS	8 →	8 →
DSR	6 →	6 →
GND	5 →	5 →
DCD	1 →	1 →
DTR	4 →	4 →
RI	9 →	9 →

Figure 56. EIA-232 Modem Cable for Terminal with 9-Pin Connector

Appendix D. Interface Conventions for the Console

Table 5 summarizes the meaning of special keys and commands that can be used by the terminal interface. You may need to configure your VT100 terminal emulation application to recognize some of these keys.

Active keys are clearly identified at the lower portion of each screen in the terminal interface.

Table 5. Special Keys and Commands Used with the Terminal Interface

Special Keys/ Text/Commands	Description
Brackets	<p>Identifies fields that can be modified.</p> <p>Angle (< >) Field entries surrounded by angle brackets identify an item that has a predefined set of options. Use the spacebar to toggle through the available values. Pressing the Esc key before moving off the field restores the current operational value to the field. The change is not activated until Apply is selected.</p> <p>Square ([]) Field entries surrounded by square brackets identify an item that can be changed by typing in text. Characters within a text field cannot be modified using the cursor keys. No insert or overwrite modes can be performed in the field. The text in the field is erased and replaced by the new text. Pressing the Esc key before moving off the field restores the current operational value to the field. The change is not activated until Apply is selected.</p>
Arrow Keys	<p>Use to move between items within the menu body, within the Command Bar, between the menu body and Command Bar. Up and Down arrow keys move the cursor between lines. Right and Left arrow keys move the cursor between columns. Arrow keys are ignored when data is entered in a text field.</p> <p>Right Arrow key The right arrow key moves the cursor to the next field to the immediate right.</p> <p>Left Arrow key The left arrow key moves the cursor to the previous field to the immediate left.</p> <p>Down Arrow key The down arrow key moves the cursor vertically down to the first character in the next row in the same position as the original row or wraps to the next section of the menu.</p> <p>Up Arrow key: The up arrow key moves the cursor vertically up to the first character in the previous row in the same position as the original row or wraps to the next section of the menu.</p>

Table 5. Special Keys and Commands Used with the Terminal Interface (continued)

Special Keys/ Text/Commands	Description
Tab	Used to move to the next field. <ul style="list-style-type: none"> When navigating between fields, Tab is used to move forward to the next field and acts like the right arrow key. When in a text field which has been modified, Tab performs the same function as the Enter key. When in a text field and no text has been changed, Tab moves you to the next field.
Shift-Tab	Not supported by VT100
Cntl-Tab	Not supported by VT100
Back Space	Used to remove the character in front of the cursor when entering text enclosed in square brackets.
Blinking Text	Warning or confirmation messages
Cursor	The software does not have control over the cursor shape. Cursor shape is controlled by the terminal emulation.
Delete	Acts like the Backspace key in a text field
End	Not supported
Enter	Used to make a selection. <ul style="list-style-type: none"> On a login screen and press Enter, the User ID and password are processed for login. On a non-leaf menu option and press Enter, the selected menu is displayed. (A non-leaf menu is a panel that contains a list of menu names that can be selected.) On the Unit ID or Slot ID and press Spacebar, the item toggles through the available values for that item. After a value is determined, pressing Enter updates the screen with the appropriate data for that Unit ID and Slot ID. On a field being modified and press Enter, the text is accepted and undergoes syntax checking and the cursor is moved to the next modifiable field. On a text field where no modifications have been made, Enter moves the cursor to the next field.
Esc	When modifying field data enclosed in square brackets ([]) or angle brackets (< >), press Esc to stop modifying the field and go back to the original data.
Home Key	Not supported
Insert	Not supported
Spacebar	When the cursor is on a modifiable field indicated by angle brackets, use the space bar to toggle through the options for that field. When the cursor is on a modifiable field indicated by square brackets, the space bar may be an allowable key to enter text.

Table 5. Special Keys and Commands Used with the Terminal Interface (continued)

Special Keys/ Text/Commands	Description
Function keys	<p>F1 Takes you to the Help Menu.</p> <p>F2 Toggles between the menu body and the Command bar. The first item is selected when toggling.</p> <p>F3 Takes you back to the previous menu.</p> <p>F4 This is the Save key and is used to save changed configuration data. It is the same as going to the System Utilities Menu and selecting Save Configuration Changes. There is no undo after configuration changes have been saved. Pressing F4 after making configuration changes causes configuration changes to be automatically Applied (F4 is used to Apply and Save configuration changes).</p>
MAC Addresses	<ul style="list-style-type: none"> • MAC addresses are displayed and entered as 12 hexadecimal digits in canonical format. • Any alphabetic character (A-F) is displayed as uppercase. When you enter the MAC address, upper and lower case characters are accepted. • Any illegal characters for a MAC address are not accepted.
Uppercase Words in the Menu	Identifies commands.
READ ONLY	When in the upper right corner of the screen, indicates that the current user has Read Only access.
UNSAVED DATA	When in the upper right corner of screen, indicates that there are unsaved changes; and that any changes made since the last SAVE was issued will not be retained across a power cycle.
SAVING DATA	After a SAVE is issued, indicates the Save is in process.
DATA SAVED	Save operation has completed successfully.
NEXT PAGE	Command used to display next screen.
PREV PAGE	Command used to display previous screen.
LOGOUT	Command used to end this login session.
CLEAR CTRS	Command used to set to 0 the counters associated with this screen.
SEND	Command used to begin sending pings.
APPLY	Command used to cause configuration changes to take effect. Apply appears on the screen once a change has been made.
REFRESH	Command used to refresh the screen with the current status or configured values.
MAIN MENU	Command used to display the Main Menu.
PREV MENU	Command used to display the previous menu screen.
HELP	Command used to display the Help Menu.

Index

Numerics

- 10/100BASE-TX feature module
 - faceplate for 8
 - LEDs for 8
- 100BASE-FX feature module
 - faceplate for 9
 - LEDs for 9
- 802.3x flow control
 - configuring for 49
 - default for 49
 - description of 49
- 802.3x protocol 2
- 8275-416
 - cable requirements for 4
 - capabilities of 1
 - connectivity 11
 - functions 1
 - functions of 1
 - hardware description of 4
 - In-band method 11
 - methods of accessing 11
 - out-of-band method 11
 - overview of 1
 - performance of 3
 - physical characteristics of 9
 - reliability 3
 - servicability 3
 - status LEDs 6
 - user interfaces available 11
 - Web site for support 15
 - Y2K (year 2000) 3
- 8275-416 , resetting default configuration 57
- 8275-416 , resetting of
 - description of 56

A

- access mode, user account management
 - defaults values 52
 - description of 52
 - range of values 52
 - read only 52
 - Read Write 52
- accessing the 8275-416 11
 - from a Web browser 15
 - in-band connectivity 13
 - out-of-band connectivity 11
 - SNMP-based management interface 14
 - terminal interface (EIA 232 port) 11
 - terminal interface (Telnet) 14
- Add, trap log operation 37
- address aging 2
- APPLY command 83
- ARP Cache 40
- ARP Cache Menu 40
- Authentication Failure, trap condition 36

B

- baud rate 12, 13
- Baud rate
 - default for 31
 - description of 31
 - value range 31
- BootP 17
- brackets
 - angle 83
 - square 83
- Bridge MIB 3
- broadcast storm recovery 2
- Broadcast Storm Recovery
 - configuring for 48
 - default for 48
 - description of 48

C

- cable requirements 4
 - lengths 4
 - types of 4
- cables
 - 100BASE-FX 4
 - 100BASE-TX 4
 - 10BASE-TX 4
- capabilities of 8275-416 1
- Category 3 4
- Category 4 4
- Category 5 4
- Clear, trap log operation 37
- CLEAR CTRS command 83
- client IP address 34
- client IP mask 34
- code download 56
- Commands
 - APPLY 83
 - CLEAR CTRS 83
 - HELP 83
 - LOGOUT 83
 - MAIN MENU 83
 - NEXT PAGE 83
 - PREV MENU 83
 - PREV PAGE 83
 - READ ONLY 83
 - REFRESH 83
 - SEND/STOP 83
 - UNSAVED DATA 83
- configuration
 - IP information 17
 - network connectivity 17
 - server 17
 - terminal interface 17
- configuration changes
 - applying 21
 - key concepts 19
 - processing 21

- configuration changes *(continued)*
 - via terminal interface 21
 - via Web interface 22
- configuration file 54
- configuration file download 56
- configuration file upload 56
- Configure Network Connectivity Menu
 - Default Gateway 29
 - description of 29
 - IP address 29
 - Subnet Mask 29
- configuring a modem 12
- configuring a port
 - numbering ports 43
- configuring a port monitoring
 - identifying the ports 45
 - numbering ports 45
- configuring IP 17
- configuring Spanning Tree
 - description of 46
 - method of redundancy 46
- conformation of password, user account management
 - defaults values 52
 - description of 52
 - range of values 52
- connectivity 11
 - attaching a modem 12
 - SNMP-based management interface 14
 - Telnet 14
 - Web-based management interface 15
- Cost, Spanning Tree Protocol
 - default for 47, 48
 - description of 47, 48

D

- danger notices, translated 67
- data bits 12, 13
- default configuration
 - description of 57
- default gateway 13, 19
- Device Configuration Menu 26
 - 802.3x Flow Control Menu 42
 - Broadcast Storm Recovery Menu 42
 - Port Configuration Menu 42
 - Port Monitoring Menu 42
 - Spanning Tree Port Configuration/Status Menu 42
 - Spanning Tree Switch Configuration/Status Menu 42
 - Switch Configuration Menu 42
- DHCP (Dynamic Host Configuration Protocol) 17
- down arrow 83
- downloading code 56
- downloading configuration file 56
- Dynamic Host Configuration Protocol (DHCP) 17

E

- Enterprise MIB 3
- error log upload 56
- Ethernet cable types
 - Category 3 4

- Ethernet cable types *(continued)*
 - Category 4 4
 - Category 5 4
- Ethernet port LEDs 7

F

- F1 function keys 83
- F2 function keys 83
- F3 function keys 83
- F4 function keys 83
- factory default configuration, resetting of 57
- fault tolerance 46
- feature module LEDs 8
- File Path 56
- File Type 55
- flow control 12, 13
- flow control, 802.3x 2
- Forward Delay Time, Spanning Tree Protocol
 - default for 47
 - description of 47
- front panel of 8275-416
 - description of 5
 - view of 5
- function keys
 - F1 83
 - F2 83
 - F3 83
 - F4 83

H

- Handling Files utility
 - description of 54
 - file name 56
 - file path 56
 - file type 55
 - TFTP Server IP Address 56
 - transfer mode 56
 - use of 54
- hardware
 - physical characteristics of 9
- hardware description
 - cable requirements 4
 - front panel 5
 - LEDs 6
- Hello Time, Spanning Tree Protocol
 - default for 47
 - description of 47
- HELP command 83

I

- in-band connectivity 11
 - BootP 13
 - description of 13
 - DHCP 13
 - IP address 13
 - use of 13
- IP address 13, 19
 - default value 35

IP address 35, 19 (*continued*)
format for 35
number ranges 35
IP information 13
methods for changing 13
IP information, configuring 17

L

Layer 2 switching 1
LEDs
for 10/100BASE-TX feature module 8
for 100BASE-FX feature module 9
for 8275-416 6
for Ethernet ports 7
for feature modules 8
left arrow 83
Link Up/Link Down, trap condition 36
locally administered MAC address 19
log in panel
user name 25
user password 25
login name 25
login password 25
LOGOUT command 83
Logout utility
description of 53
use of 53

M

MAC address type 19
MAC addresses 83
Main Menu
Device Configuration Menu 26
Management Menu 26
Statistics Menu 26
System Information Menu 26
System Utilities Menu 26
User Account Management Menu 26
MAIN MENU command 83
Management interfaces
VT100 terminal interface 2
Management Menu 26
ARP Cache Menu 29
description of 29
functions available 29
how to access 29
Network Connectivity Configuration Menu 29
Ping Menu 29
Serial Port Configuration Menu 29
Server Configuration Menu 29
SNMP Community Configuration Menu 29
SNMP Trap Receiver Configuration Menu 29
Telnet Menu 29
Trap Menu 29
view of 29
Maximum Age Time, Spanning Tree Protocol
default for 47
description of 47
menu command
descriptions of 83

MIB II 3
MIBs supported
8275-416 MIB 14
Bridge MIB 2
Enterprise MIB 2
MIB II 2
RFC 1213 14
RFC 1493 14
RFC 1643 14
RFC 1757 14
RMON MIB 2
Web page for latest 14
modem
setting for 12
modem configuration 12
Multiple Users, trap condition 36

N

Name trap log entry 37
Network Configuration Protocol
Default for 33
description of 33
network connectivity configuration 18
Network Connectivity Configuration Menu 29
NEXT PAGE command 83
numbering ports 44

O

obtaining service 65
obtaining software 63
operating environment
humidity 9
temperatures 9
out-of-band connectivity 11
description of 11
locally attached 11
remotely attached 12
use of 11

P

parity 12, 13
password
defaults for 25
description of 25
number supported 25
requirements for 25
Password, user account management
defaults values 52
description of 52
range of values 52
performance 3
physical characteristics
depth 9
height 9
operating environment 9
physical dimensions 9
service clearance 9
weight 9

- physical characteristics *(continued)*
 - width 9
- physical dimensions 9
- Ping
 - configuration of 39
 - description of 39
 - IP address 39
 - limits on number of 39
 - starting and stopping 39
- Ping Menu 39
- port configuration
 - numbering ports 43
- port detailed statistics 51
- port LEDs 7
- port monitoring 3
- port monitoring configuration
 - default values 45
 - identifying the ports 45
 - numbering ports 45
- port statistics 3
- port summary statistics 51
- port switching
 - number of ports 3
 - packet processing rates 3
- PREV MENU command 83
- PREV PAGE command 83
- Priority, Spanning Tree Protocol
 - default for 47, 48
 - description of 47, 48
- Private 34
- product overview 1
- protocols supported
 - 802.3x protocol 2
 - IEEE P802.1D 1
- Public 34

R

- READ ONLY 83
- redundant paths 3, 46
- REFRESH command 83
- reliability 3
- resetting the 8275-416 56, 57
- RFC 1213 3
- RFC 1493 3
- RFC 1757 3
- right arrow 83
- RMON MIB 3

S

- safety notices, translated 67
- Save Applied Changes utility
 - description of 53
 - use of 53
- security
 - access mode 52
 - configuring user names 52
 - configuring user password 52
 - read only 34
 - Read Write 34
 - SNMP read/write 3

- security *(continued)*
 - status 52
 - user accounts 3
- SEND/STOP command 83
- Serial Port Configuration Menu
 - Baud rate 30
 - description of 30
 - Time out 30
- server configuration 17
- Server Configuration Menu
 - description of 31
 - Network Configuration Protocol 31
 - Unit ID 31
- servicability 3
- Service
 - diagnosing problems 63
 - obtaining 63
 - obtaining software 63
- service
 - telephone numbers for 66
- service, Web site for 63
- service clearance
 - front 9
 - rear 9
 - sides 9
- Simple Network Management Protocol (SNMP)
 - agent 2
- SNMP-base management interface 14
- SNMP-based management interface
 - description of 14
 - groups supported 14
 - MIBs supported 14
 - use of 14
- SNMP community
 - client IP address 34
 - client IP mask 34
 - status 34
- SNMP community access right
 - description of 34
 - read only 34
 - Read Write 34
- SNMP Community Configuration Menu
 - access right 33
 - community name 33
 - description of 33
 - status 33
- SNMP Community Name
 - default names
 - Private 34
 - Public 34
- SNMP community name
 - default values 35
- SNMP Community Name
 - description of 34
- SNMP community name
 - format for 35
- SNMP Community Name
 - value length 34
- SNMP interface
 - making configuration changes 23
 - processing configuration changes 23

SNMP interface (*continued*)
saving configuration changes 23

SNMP trap receiver
community string 35
configuration of 35
description of 35
IP address 35
status 35

SNMP Trap Receiver Configuration Menu
configuration of 35
description of 35
number supported 35

SNMP trap receiver status
default values 35
description of 35

software functions
802.3x flow control 2
address aging 2
broadcast storm recovery 2
Layer 2 switching 1

downloading files to the 8275-416 54

Spanning Tree, trap condition 36

Spanning Tree Protocol (STP) 3
configuring for 46
defining Status 47

special keys
Backspace 83
brackets
angle 83
square 83
Cntl-Tab 83
Delete 83
down arrow 83
End 83
Enter 83
Esc 83
Insert 83
left arrow 83
right arrow 83
Shift-Tab 83
Tab 83
up arrow 83

statistics
description of 50
how to access 50

Statistics Menu 26
contents of 50
description of 50
detailed port statistics 50
summary of port statistics 50

Status, Spanning Tree Protocol
default for 47
description of 47

status, user account management
defaults values 53
description of 53
Disable 53
Enable 53
range of values 53

stop bits 12, 13

STP (Spanning Tree Protocol) 3, 46

subnet mask 19

subnet mask 13

System Information Menu
description of 26
how to access 26
options available 26
view of 26

system trace upload 56

System Utilities Menu 26
Debug Information Menu 53
description of 53
Download File to Switch Menu 53
Logout 53
Reset Menu 53
Save Applied Changes 53
Upload File to Switch Menu 53
utilities available 53

T

Telnet configuration
default number of sessions 38
description of 38
length of sessions 38
limiting number of sessions 38
sessions allowed 38

Telnet Login Timeout 39

Telnet Menu 38

Telnet sessions
duration of 39
limiting new sessions 39
maximum number of 39

terminal emulation setting
baud rate 12, 13
data bits 12, 13
flow control 12, 13
parity 12, 13
stop bits 12, 13

terminal interface
applying changes 21
blinking text 83
command descriptions 83
commands

APPLY 83
CLEAR CTRS 83
HELP 83
LOGOUT 83
MAIN MENU 83
NEXT PAGE 83
PREV MENU 83
PREV PAGE 83
REFRESH 83
SEND/STOP 83
UNSAVED DATA 83

configuring terminal emulation 11

Cursor 83

description of 2

Main Menu 26

making changes 20

menu commands 83

steps for connecting the terminal and 8275-416 12

- terminal interface (*continued*)
 - terminal interface
 - saving applied changes 21
 - use of 2
 - using the 25
 - via Telnet 14
 - via the EIA 232 serial port 11
- terminal interface (EIA 232)
 - description of 11, 14
 - use of 11, 14
- TFTP Server IP Address 56
- Time out
 - default for 31
 - description of 31
 - value range 31
- Time Stamp trap log entry 37
- Transfer Mode 56
- translations, safety notices 67
- trap conditions
 - Authentication Failure 36
 - Console Display 36
 - description of 36
 - Link Down 36
 - Link Up 36
 - Multiple Users 36
- trap configuration
 - conditions for 36
 - description of 36
- trap log
 - description fo 37
 - Name entry 37
 - number of entries 37
 - Time Stamp entry 37
 - valid operations of 37
- trap log upload 56
- Trap Menu 36
- traps
 - Authentication Failure 37
 - Cold Start 37
 - Link Down 37
 - Link Up 37
 - Multiple Users 37
 - New Spanning Tree Root 37
 - Spanning Tree Topology Change 37
 - Warm Start 37
- Traverse, trap log operation 37

U

- Unit ID
 - description of 33
 - range of values 33
- UNSAVED DATA command 83
- up arrow 83
- uploading configuration file 56
- uploading error log 56
- uploading files from the 8275-416 54
- uploading system trace 56
- uploading trap log 56
- uppercase words 83
- user access
 - access mode 52

- user access (*continued*)
 - configuring user names 52
 - configuring user password 52
 - status 52
- user account management 52
- User Account Management Menu 26
- user name
 - defaults for 25
 - description of 25
 - number supported 25
 - requirements for 25
- User Name, user account management
 - defaults values 52
 - description of 52
 - range of values 52

V

- VT 100 terminal, configuration settings for 12

W

- Web-based management interface 14, 15
- Web browser 15
- Web interface
 - making configuration changes 22
 - processing configuration changes 22
 - saving configuration changes 23
- Web sit for service 63
- weight 9

Y

- Y2K (year 2000)
 - compliance statement 3
 - Web site for 3

Readers' Comments — We'd Like to Hear from You

**8275 Model 416 High Performance Ethernet Workgroup Switch
User's Guide**

Publication No. GC30-4026-00

Overall, how satisfied are you with the information in this book?

	Very Satisfied	Satisfied	Neutral	Dissatisfied	Very Dissatisfied
Overall satisfaction	<input type="checkbox"/>	<input type="checkbox"/>	<input type="checkbox"/>	<input type="checkbox"/>	<input type="checkbox"/>

How satisfied are you that the information in this book is:

	Very Satisfied	Satisfied	Neutral	Dissatisfied	Very Dissatisfied
Accurate	<input type="checkbox"/>	<input type="checkbox"/>	<input type="checkbox"/>	<input type="checkbox"/>	<input type="checkbox"/>
Complete	<input type="checkbox"/>	<input type="checkbox"/>	<input type="checkbox"/>	<input type="checkbox"/>	<input type="checkbox"/>
Easy to find	<input type="checkbox"/>	<input type="checkbox"/>	<input type="checkbox"/>	<input type="checkbox"/>	<input type="checkbox"/>
Easy to understand	<input type="checkbox"/>	<input type="checkbox"/>	<input type="checkbox"/>	<input type="checkbox"/>	<input type="checkbox"/>
Well organized	<input type="checkbox"/>	<input type="checkbox"/>	<input type="checkbox"/>	<input type="checkbox"/>	<input type="checkbox"/>
Applicable to your tasks	<input type="checkbox"/>	<input type="checkbox"/>	<input type="checkbox"/>	<input type="checkbox"/>	<input type="checkbox"/>

Please tell us how we can improve this book:

Thank you for your responses. May we contact you? Yes No

When you send comments to IBM, you grant IBM a nonexclusive right to use or distribute your comments in any way it believes appropriate without incurring any obligation to you.

Name

Address

Company or Organization

Phone No.



Cut or Fold
Along Line

Fold and Tape

Please do not staple

Fold and Tape



NO POSTAGE
NECESSARY
IF MAILED IN THE
UNITED STATES

BUSINESS REPLY MAIL

FIRST-CLASS MAIL PERMIT NO. 40 ARMONK, NEW YORK

POSTAGE WILL BE PAID BY ADDRESSEE

Department CGFA—Design and Information Development
IBM Corporation
P.O. Box 12195
Research Triangle Park, NC, U.S.A. 27709-9990

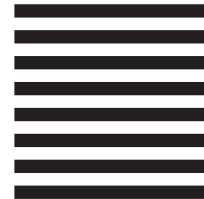

Fold and Tape

Please do not staple

Fold and Tape

Cut or Fold
Along Line



Printed in the United States of America
on recycled paper containing 10%
recovered post-consumer fiber.

GC30-4026-00

